

ROBAN

Instruction manual

Scale Fuselage MD500D/E

700 size



1. INTRODUCTION

Thank you for buying Roban Model products. The 600 size MD500D/E scale fuselage is designed as an easy to use product. Please read the manual carefully before assembling the model, and follow all precautions and recommendations located within the manual. Be sure to retain the manual for future reference, routine maintenance and tuning. The scale fuselage is designed for T-REX 600 Helicopter series use. You can easily put it on your T-REX 600 for new clothing.

Important Note

Roban Model R/C Helicopters are advanced, high-performance devices, built incorporating the latest technologies. They are not intended as toys, and improper use can potentially lead to serious injury, or even fatal accidents. We implore you to read this manual thoroughly before operating these models. Safety should be your utmost priority - not just your own, but also that of others and your surroundings when piloting Roban Model products.

Liability Disclaimer:

The manufacturer and the seller cannot accept liability for the operation or misuse of this product. Roban Model R/C helicopters are intended to be used exclusively by experienced adults in legally sanctioned flying fields. Once sold, we cannot monitor or control the product's operation or usage.

Operation Guidelines:

Upon assembly of the scale fuselage, the weight and complexity of the structure will increase. To mitigate risk of accidents and damages, we advise against attempting 3D flights.

Skill Requirements:

The operation of R/C products necessitates a certain level of skill and familiarity. Any damages or dissatisfaction resulting from accidents, modifications, or operational mishaps are not covered under

ROBAN

any warranty. Consequently, such products cannot be returned for repair or if you experience problems during operation or maintenance.

2. OPERATIONAL GUIDELINES FOR SAFETY IN USING R/C AIRCRAFT MODELS

Safety Zone:

Prioritize the safety of others by operating R/C aircraft models in isolated areas, free of bystanders. Avoid piloting these models near residential zones or large groups of people.

Operational Risks:

Be aware that R/C aircraft models are susceptible to accidents, malfunctions, and crashes. These may result from a range of factors such as inadequate maintenance, pilot errors, or radio interference. Understanding these risks is crucial for safe operation.

Pilot Responsibility:

Pilots bear the sole responsibility for any damage or injuries that may occur during operation or as a result of using R/C aircraft models. By undertaking the control of these devices, you accept accountability for your actions and their possible consequences. Always aim for caution and responsible handling to minimize any potential risks.

3. CONTENTS OF KIT

Please check the contents of the kit prior to installation.

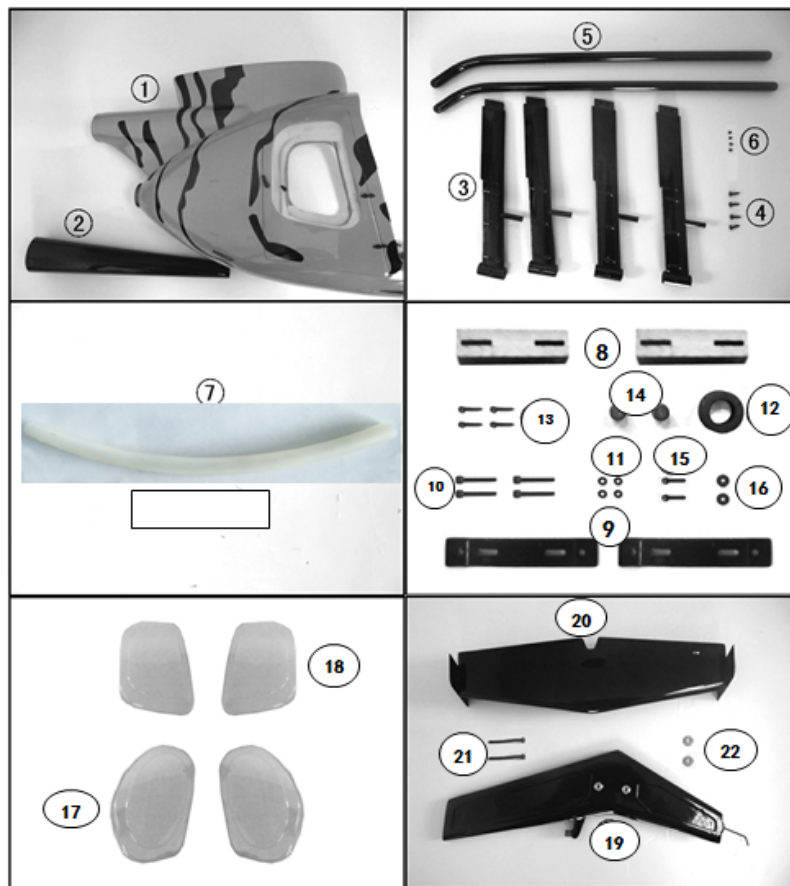

ROBAN

CONTENTS

Item No.	Description	Quantity
1	Fuselage	x1
2	Tail boom	x1
3	Landing gear struts	x4
4	Screw A3x12	x4
5	Landing gear skids	x2
6	Screw M3x3	x4
7	Hose 300x14	x1
8	Washers	x2
9	Mounting blocks	x2
10	Screw M3x45	x4
11	Washer M3	x4
12	EVA rear rubber	x1
13	Screw A3x12	x4
14	Lights	x2
15	Screw M3x12	x2
16	Washer M3	x2
17-18	Window panes	x4
19	Tail fin	x1
20	Tail unit	x1
21	Screw M3x35	x2
22	Washer M3	x2

REQUIRED TOOLS / CONSUMABLES

Tool No.	Tool/Consumable
1	Hobby knife
2	Allen wrench
3	Phillips screwdriver
4	File
5	Side cutters
6	Silicone adhesive
7	Super glue
8	2K Epoxy glue
9	Fine sandpaper
10	Scissors

ROBAN

4. INSTALLATION

- 4.1 Assemble the tail boom as shown using epoxy resin adhesive.

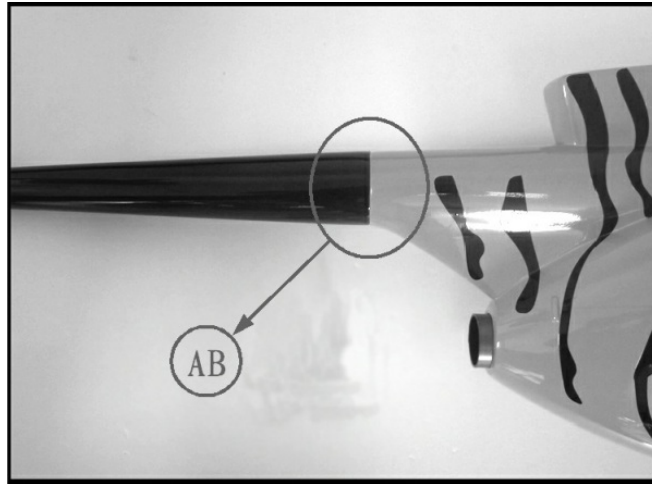

- 4.2 Mount the struts as shown.

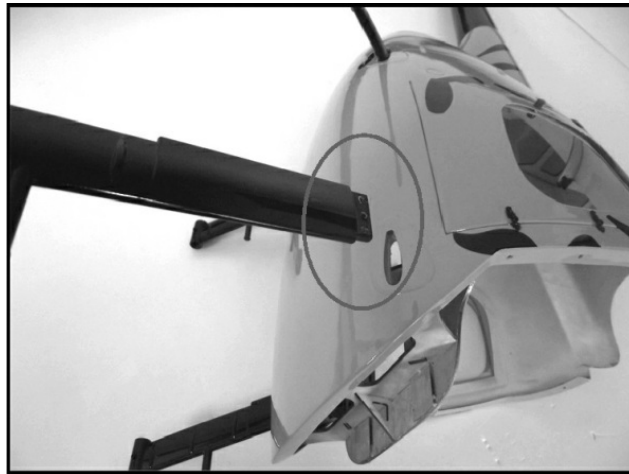

- 4.3 Insert the skids into the struts as shown.

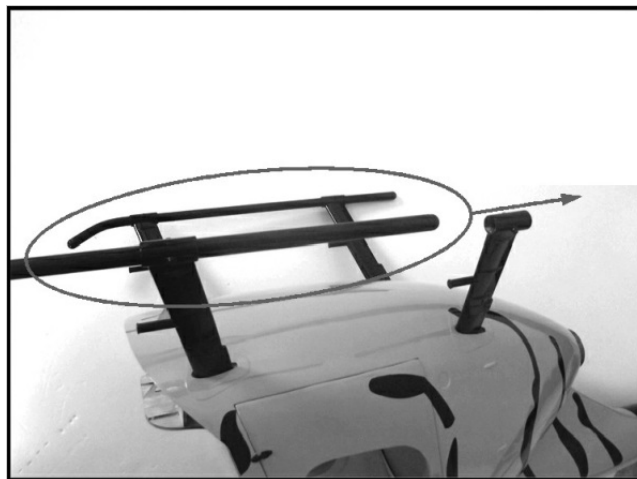

ROBAN

4.4 Secure the skids with 4 set screws M3x4 as shown.

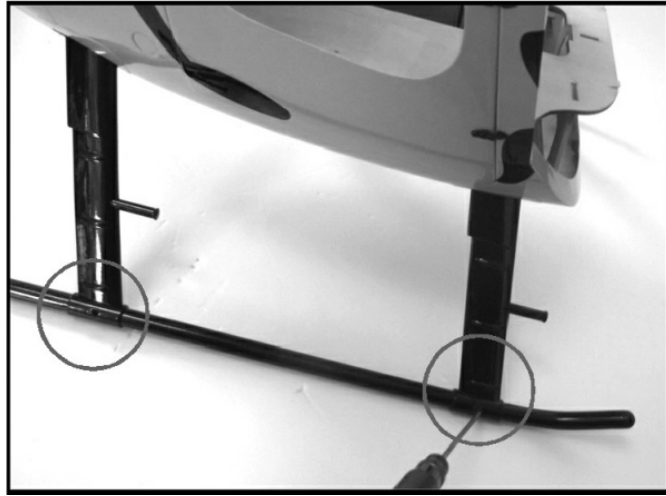

4.5 Fix the struts with 4 screws M3x12 as shown.

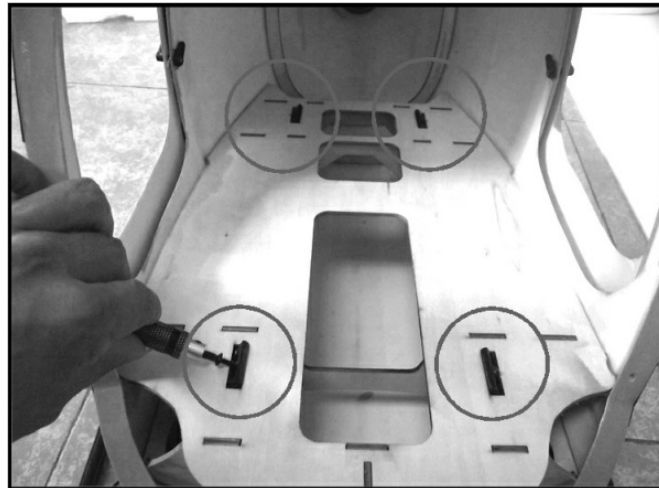

4.6 Assemble the tail bracing as shown.

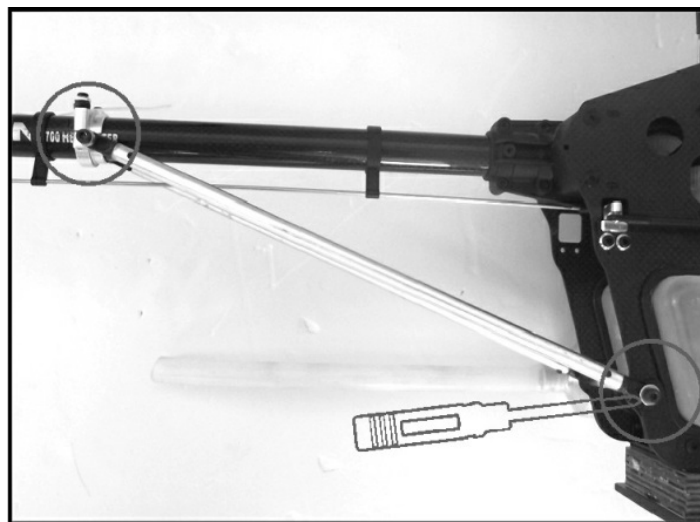

ROBAN

4.7 Glue the washers as shown.

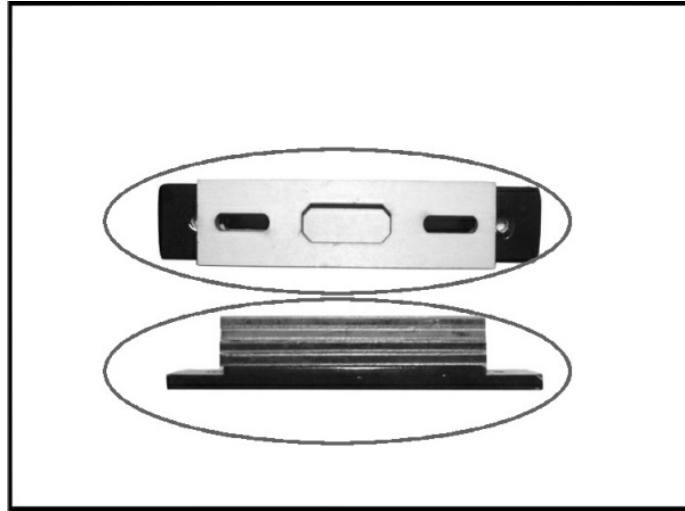

4.8 Mount the washers with screw M3x45 and washer M3.

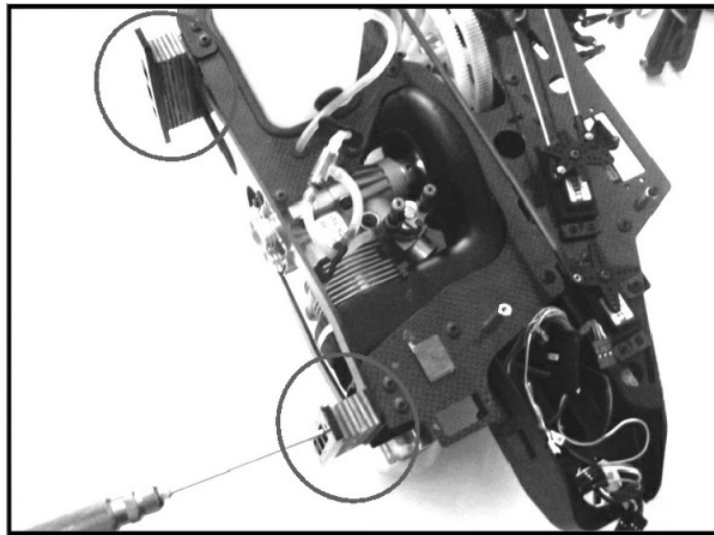

4.9 Insert the mechanism into the fuselage as shown.

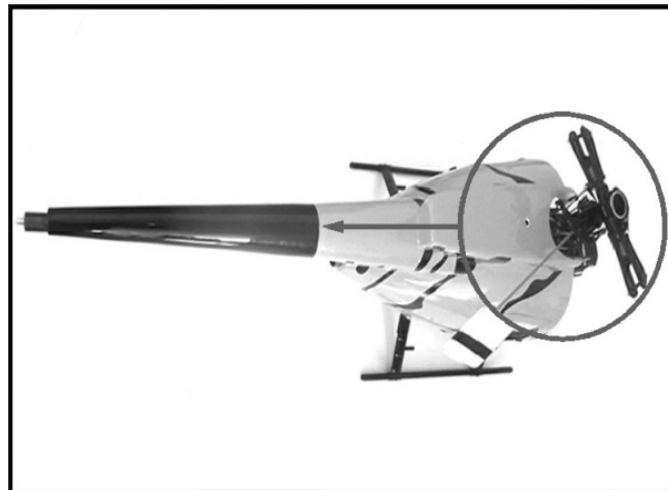

ROBAN

4.10 Ensure that the tail linkage exits as shown.

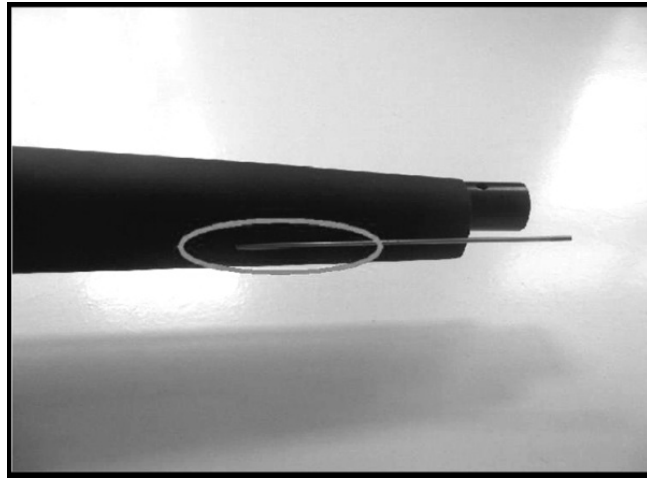

4.11 Install the rear rubber as shown.

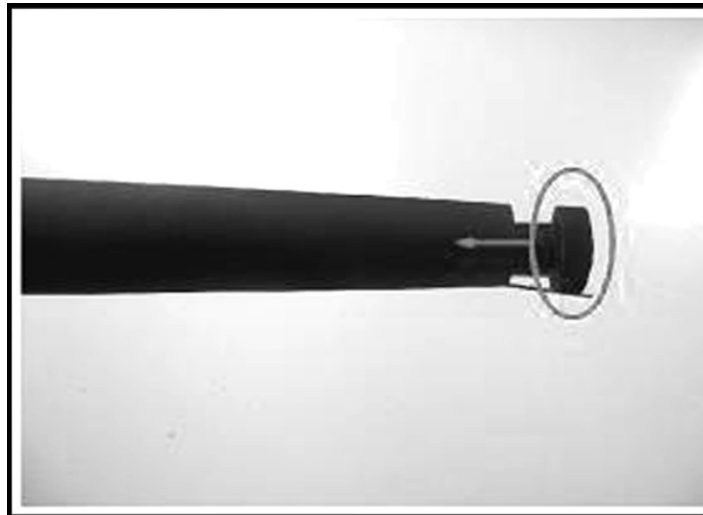

4.12 Assemble the tail rotor.

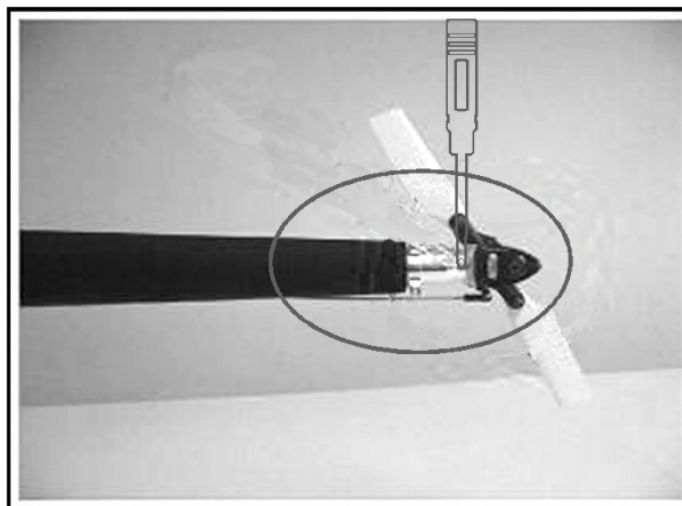

ROBAN

4.13 Secure the mechanism with 4 screws A3x12 in the fuselage.

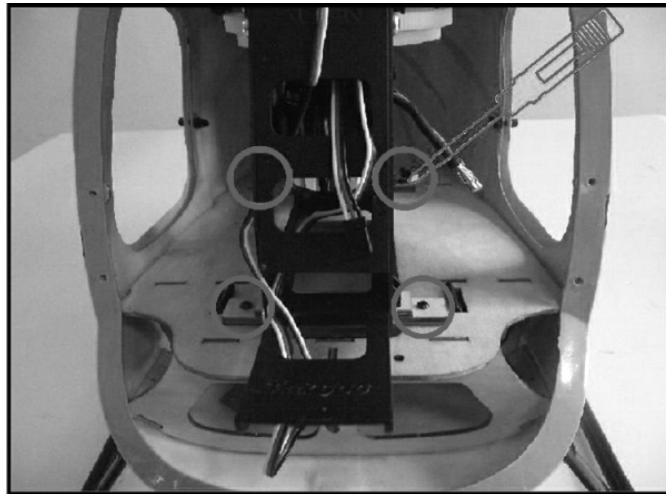

4.14 Glue in the LED cover.

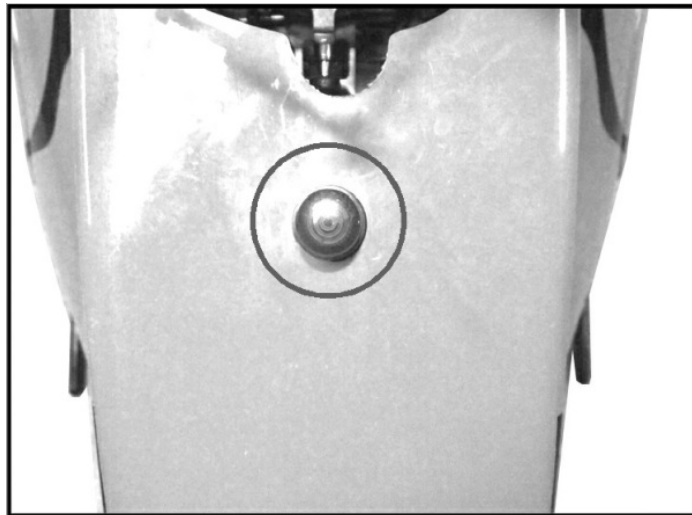

4.15 Glue in the LED cover.

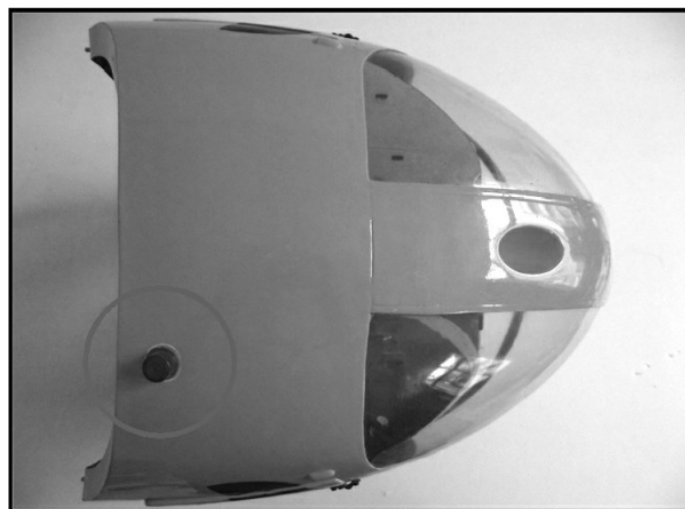

ROBAN

4.16 Glue in the large windows.

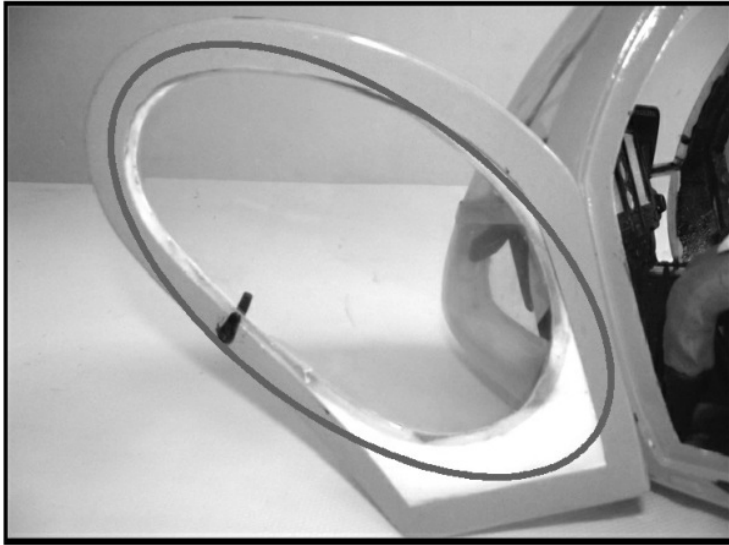

4.17 Glue in the tail window with epoxy resin adhesive.



4.18 Glue the tail unit with epoxy resin.

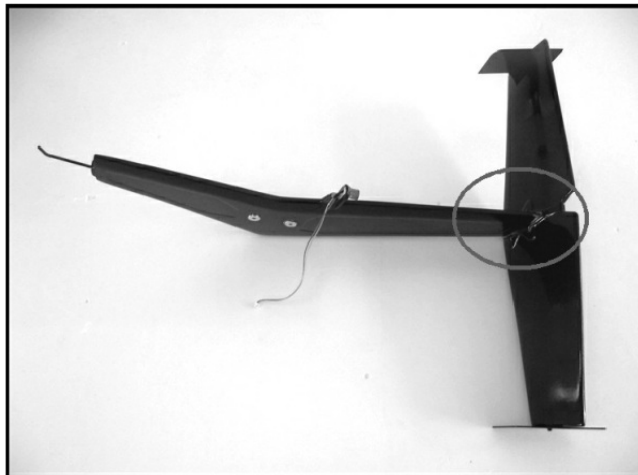

ROBAN

4.19 Screw the tail unit with M3x12 and washer M3.

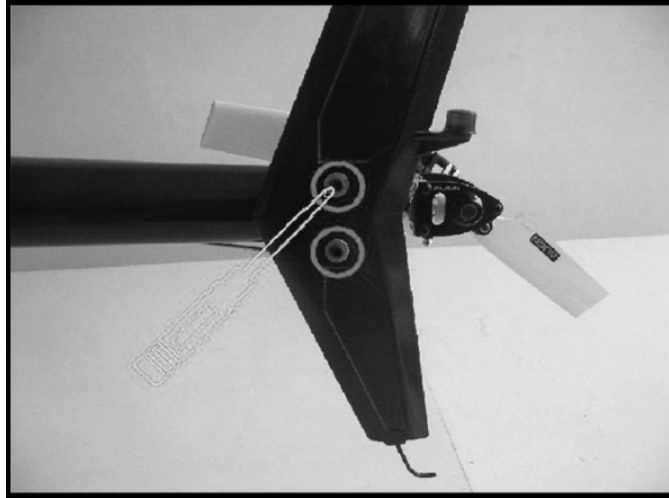

4.20 Secure the canopy with screw M3x12 and washer M3. Do not fly without securing the canopy with this screw. It will fall off.

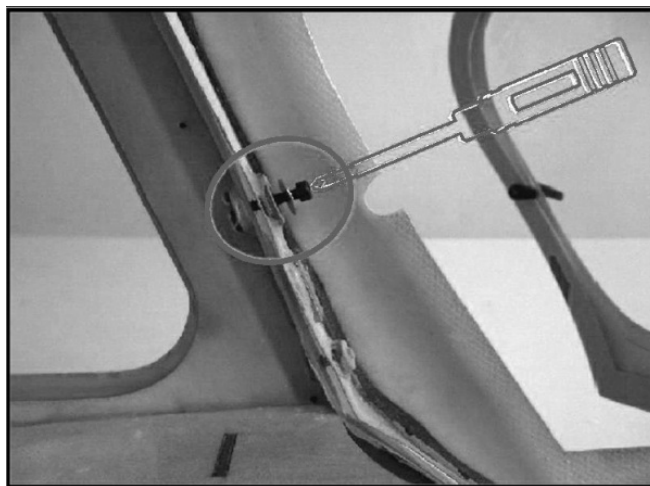

5. SPAREPART LIST

HSB- MD700GJB-E	MD700EPJ001		700MD500E 前 头	700 MD500E canopy
--------------------	-------------	---	------------------	----------------------

ROBAN

	MD700EPJ002		700MD500E 前窗	700 MD500E front window set
	MD700EPJ003		700MD500E 全套窗	700 MD500E window set
	MD700EPJ004		700MD500E 平垂尾	700 MD500E tail fins
	MD700EPJ005		700MD500E 脚架组	700 MD500E landing gear
	MD700EPJ006		700MD500E 固定件	700 MD500E mounting hardware
	MD700EPJ007		700MD500E 像真件	700 MD500E scale parts
	MD700EPJ008		700MD500E 探照灯	700 MD500E front light
	MD700EPJ009		700MD500ELED灯	700 MD500E
	MD700EPJ010		700MD500E 水印	700 MD500E decals

ROBAN

6. FULLY ASSEMBLED FUSELAGE

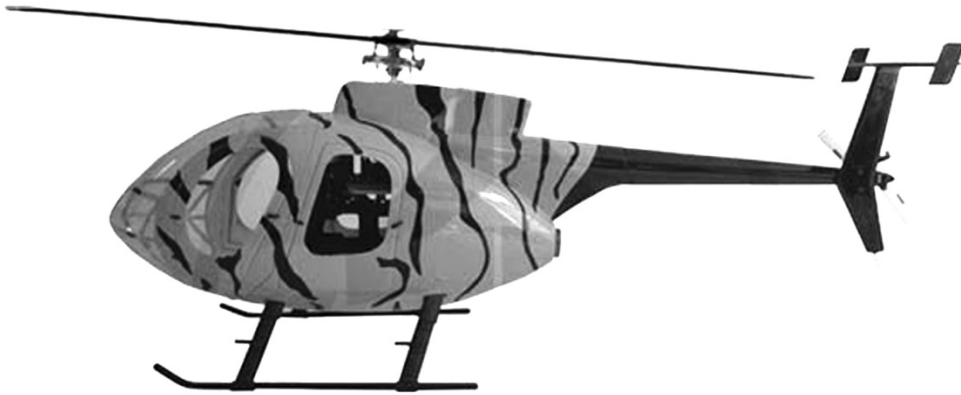

Specifications:

Length: 1430mm

Height: 515mm

Width: 410mm

Weight: 1695g

Suitable for Align TREX700 and derivatives

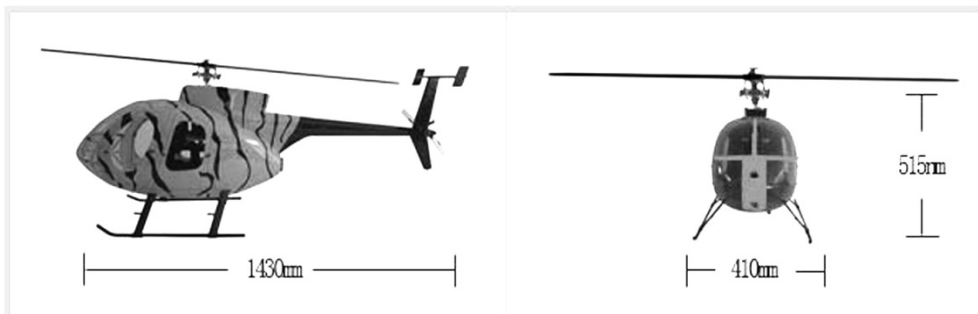

We wish you a lot of fun with the fuselage!

ROBAN

Copyright 2024 – www.robamodel.com