

# Super Combo DOMINATOR T-REX 550L

# ALIGN

## INSTRUCTION MANUAL 使用說明書

RH55E09XT



### Contents

1	INTRODUCTION 前言
1-2	SAFETY NOTES 安全注意事項
3	EQUIPMENT REQUIRED FOR ASSEMBLY 組裝設備
3	PACKAGE ILLUSTRATION 包裝說明
4	SAFETY CHECK BEFORE FLYING 飛行前安全檢查重要事項
5-15	ASSEMBLY SECTION 組裝說明
16	EQUIPMENT INSTALLATION 各項設備配置
17	BATTERY INSTALLATION ILLUSTRATION 電池安裝示意圖
18	INSTALLATION FOR ESC 無刷调速器安裝
18	CANOPY ASSEMBLY 機頭罩安裝
19	ELECTRIC EQUIPMENT ILLUSTRATION 電子設備連接配置圖示
20	SERVO SETTING AND ADJUSTMENT 伺服器設定調整
20	ADJUSTMENTS FOR GYRO AND TAIL NEUTRAL SETTING 陀螺儀與尾翼中立點設定調整
21	PITCH AND THROTTLE SETTING 主旋翼螺距與油門設定
22-33	Gpro FLYBARLESS MANUAL 數字平衡系統使用說明
34	RCM-BL730MC 650KV POWER COLLOCATION REFERENCE 原裝動力數據參考表
34-35	CASTLE TALON 90 BRUSHLESS ESC INSTRUCTION MANUAL CASTLE TALON 90 無刷调速器使用說明
36-37	Gpro FLYBARLESS PREFLIGHT CHECK 飛行前測試程序
37-40	FLIGHT ADJUSTMENT AND SETTING 飛行動作調整與設定
41	TROUBLESHOOTING 飛行中狀況排除
42	Q & A 問與答



## GPRO FLYBARLESS SYSTEM



SPAN ENG DE FR IT ES PT NL BG RO CS SK PL HR CZ SI EL GR TR RU UA ZH TW TH VI ID



Thank you for buying ALIGN products. The T-REX 550L Dominator is the latest technology in Rotary RC models. Please read this manual carefully before assembling and flying the new T-REX 550L Dominator helicopter. We recommend that you keep this manual for future reference regarding tuning and maintenance.

承蒙閣下選用亞拓遙控世界系列產品，謹表謝意。進入遙控世界之前必須告訴您許多相關的知識與注意事項，以確保您能夠在學習的過程中較得心應手。在開始操作之前，請務必詳閱本說明書，相信一定能夠給您帶來相當大的幫助，也請您妥善保管這本說明書，以作為日後參考。

Thank you for buying ALIGN Products. The T-REX 550L Dominator Helicopter is designed as an easy to use, full featured Helicopter R/C model capable of all forms of rotary flight. Please read the manual carefully before assembling the model, and follow all precautions and recommendations located within the manual. Be sure to retain the manual for future reference, routine maintenance, and tuning. The T-REX 550L Dominator is a new product developed by ALIGN. It features the best design available on the Micro-Heli market to date, providing flying stability for beginners, full aerobically capability for advanced fliers, and unsurpassed reliability for customer support.

感謝您選購亞比產品。為了讓您容易方便的使用 T-REX 550L Dominator 直升機，請您詳細的閱讀完本說明書之後再進行組裝以及操作這台直升機。同時請您妥善的保存這本說明書，作為日後進行調整以及維修的參考。T-REX 550L Dominator 是由亞比自行研發的新產品，不論是需求飛行穩定性的初學者或是追求性能的飛行愛好者，T-REX 550L Dominator 將是您最佳的選擇。

### WARNING LABEL LEGEND 標誌代表意義

	<b>Do not attempt under any circumstances.</b> 在任何禁止的環境下，請勿嘗試操作。
	<b>Mishandling due to failure to follow these instructions may result in damage or injury.</b> 因為疏忽這些操作說明，而使用錯誤可能造成財產喪失或嚴重傷害。
	<b>Mishandling due to failure to follow these instructions may result in danger.</b> 因為疏忽這些操作說明，而使用錯誤可能造成危險。

### IMPORTANT NOTES 重要聲明

R/C helicopters, including the T-REX 550L Dominator are not toys. R/C helicopter utilize various high-tech products and technologies to provide superior performance. Improper use of this product can result in serious injury or even death. Please read this manual carefully before using and make sure to be conscious of your own personal safety and the safety of others and your environment when operating all ALIGN products. Manufacturer and seller assume no liability for the operation or the use of this product. This product is intended for use only by adults with experience flying remote control helicopters at a legal flying field. After the sale of this product we cannot maintain any control over its operation or usage.

As the user of this product, you are solely responsible for operating it in a manner that does not endanger yourself and others or result in damage to the product or the property of others.

T-REX 550L Dominator 遙控直升機並非玩具。它結合了許多高科技產品所設計出來的休閒用品，所以商品的使用不當或不熟悉都可能造成嚴重傷害甚至死亡。使用之前請務必詳讀本說明書，勿輕忽並注意自身安全。注意！任何遙控直升機的使用、製造商和經銷商是無法對使用者於零件使用的錯誤與或組裝不當所發生之意外負任何責任。本產品是提供給有操作過模型直升機經驗的成人或有相當技術的人在旁指導於當地合法遙控飛行場飛行。以確保安全與操作使用。產品售出後本公司將不負任何操作及使用控制上之任何性與安全責任。

做為本產品的使用者，您，是唯一對於您自己操作的環境及行為負全部的責任之人。

We recommend that you obtain the assistance of an experienced pilot before attempting to fly our products for the first time. A local expert is the best way to properly assemble, setup, and fly your model for the first time. The T-REX 700L DOMINATOR HV requires a certain degree of skill to operate, and is a consumer item. Any damage or dissatisfaction as a result of accidents or modifications are not covered by any warrantee and cannot be returned for repair or replacement. Please contact our distributors for free technical consultation and parts at discounted rates when you experience problems during operation or maintenance. As Align Corporation Limited has no control over use, setup, final assembly, modification or misuse, no liability shall be assumed nor accepted for any resulting damage or injury. By the act of use, setup or assembly, the user accepts all resulting liability.

模型產品屬於高技術且為消耗性之商品。如經拆裝使用後，會造成不等情況零件損耗。任何使用情況所造成商品不組或不滿意，將無法於保證條件內更換新品或退貨。如遇有使用操作維修問題，本公司各分公司或代理商將提供技術指導、替換零件供應服務。對使用者的不當使用、設定、組裝、修改、或操作不良所造成的破壞或傷害，本公司無法控制及負責。任何使用、設定、組裝、修改、或操作不良所造成的破壞、意外或傷害，使用者應承擔全部責任。

### 2. SAFETY NOTES 安全注意事項

	<ul style="list-style-type: none"> <li>• Fly only in safe areas, away from other people. Do not operate R/C aircraft within the vicinity of homes or crowds of people. R/C aircraft are prone to accidents, failures, and crashes due to a variety of reasons including, lack of maintenance, pilot error, and radio interference. Pilots are responsible for their actions and damage or injury occurring during the operation or as a result of R/C aircraft models.</li> <li>• Prior to every flight, carefully check rotorhead spindle shaft screws and tail blade grip screws, linkage balls and screws, ensure they are firmly secured.</li> <li>• 遙控模型飛機、直升機屬高消耗性商品。飛行時務必適量人羣。人為組裝不當或零件損壞、電子控制設備不良、以及操作上的不熟悉、都有可能導致飛行失控損傷等不可預期的意外。請飛行者務必注意飛行安全，並需了解商品負造成任何意外之責任。</li> <li>• 每趟飛行前須仔細檢查，主翼夾夾座鎖螺絲、尾翼夾夾座螺絲，以及機身各部位球頭、螺絲。確實上膠膠墊才能升空飛行。</li> </ul>
--	--

**LOCATE AN APPROPRIATE LOCATION 遠離障礙物及人群**

RC 直升機飛行時具有一定的速度，相對的也潛在著危險性，場地的選擇也相對的重要。請遵守當地法規到合法指定飛行場地飛行。務必選擇在不影響合法專飛飛行場地。若必須在居民區還有沒有人、高樓、建築物、高壓電線、樹木等等，避免操控的不當造成自己與他人財產的損壞。

請勿在下雨、打雷等惡劣天氣下操作，以確保本身及機體的安全。



真昇機飛行時具有一定的速度，相對的也潛在著危險性，場地的選擇也相對的重要。請遵守當地法規到合法指定飛行場地飛行。務必選擇在不影響合法專飛飛行場地。若必須在居民區還有沒有人、高樓、建築物、高壓電線、樹木等等，避免操控的不當造成自己與他人財產的損壞。

請勿在下雨、打雷等惡劣天氣下操作，以確保本身及機體的安全。

**NOTE ON LITHIUM POLYMER BATTERIES 避賢電池注意事項**

Lithium Polymer batteries are significantly more volatile than alkaline or Ni-Cd/Ni-MH batteries used in RC applications. All manufacturer's instructions and warnings must be followed closely. Mishandling of Li-Po batteries can result in fire. Always follow the manufacturer's instructions when disposing of Lithium Polymer batteries.

避賢電池跟一般用在 RC 使用的鹼性電池、鎳鎘電池、鎳氫電池比較起來是相對危險的。請嚴格遵守避賢電池說明書之使用注意事項。不恰當使用避賢電池，可能造成火災並傷及生命財產安全。切勿大意！

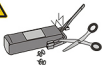
**PREVENT MOISTURE 遠離潮濕環境**

RC models are composed of many precision electrical components. It is critical to keep the model and associated equipment away from moisture and other contaminants. The introduction or exposure to water or moisture in any form can cause the model to malfunction resulting in loss of use, or a crash. Do not operate or expose to rain or moisture.

真昇機內部也是由許多精密的電子零件組成，所以必須絕對的防止濕氣或水氣。避免在浴室或雨天時使用，防止水氣進入機身內部導致機件及電子零件故障而引發不可預期的意外！

**PROPER OPERATION 勿不當使用本產品**

Please use the replacement of parts on the manual to ensure the safety of instructors. This product is for RC model, so do not use for other purpose.

請勿自行改造加工，任何升級改造或維修，請使用 O 標產品內建中的零件，以確保結構的安全。請務必於產品說明書內作，請勿過載使用，並勿用於安全、法等外其他用途。

**OBTAIN THE ASSISTANCE OF AN EXPERIENCED PILOT 避免獨自操控**

Before turning on your model and transmitter, check to make sure no one else is operating on the same frequency. Frequency interference can cause your model, or other models to crash. The guidance provided by an experienced pilot will be invaluable for the assembly, tuning, trimming, and actual first flight or unforeseen danger may happen. (Recommend you to practice with computer-based flight simulator.)

要飛行前飛行前，高聲確認是否有相同頻率的機友正在進行飛行，因為頻帶相同頻率的機友將導致自己與他人立即墜機等意外危險。避賢飛機操控技巧在學前初期有著一定的難度，盡量避免獨自操作飛行。若有經驗的人士在旁指導，才可以該機飛行，否則將可能造成不可預期的意外發生。(動機電腦模擬器及老手指導是入門必要的選擇)

**SAFE OPERATION 安全操作**

Operate this unit within your ability. Do not fly under tired condition and improper operation may cause in danger. Never take your eyes off the model or leave it unattended while it is turned on. Immediately turn off the model and transmitter when you have landed the model.

請於自己能力內及適當一定技術範圍內操作平台自昇昇。過於疲勞、精神不佳或不當操作，意外發生風險將會提高。不可在低視範圍外飛行，降落後也請馬上關閉真昇機和避賢電池。

**ALWAYS BE AWARE OF THE ROTATING BLADES 遠離運轉中零件**

During the operation of the helicopter, the main rotor and tail rotor will be spinning at a high rate of speed. The blades are capable of inflicting serious bodily injury and damage to the environment. Be conscious of your actions, and careful to keep your face, eyes, hands, and loose clothing away from the blades. Always fly the model a safe distance from yourself and others, as well as surrounding objects.

真昇機主旋翼與尾旋翼運轉時會以高轉速下進行，在高轉速下的旋翼會造成自己與他人或在環境上的嚴重損傷。請勿觸摸運轉中的主旋翼與尾旋翼，並保持安全距離以避免造成危險及損壞。

**KEEP AWAY FROM HEAT 遠離熱源**

RC models are made of various forms of plastic. Plastic is very susceptible to damage or deformation due to extreme heat and cold climate. Make sure not to store the model near any source of heat such as an oven, or heater. It is best to store the model indoors, in a climate-controlled, room temperature environment.

避賢飛機多半是以 PA 纖維或聚乙稀、電子產品為主要材質，因此要盡量遠離熱源、日曬，以避免因高溫而造成變形甚至熔毀損壞的可能。



## RADIO TRANSMITTER AND ELECTRONIC EQUIPMENT REQUIRED FOR ASSEMBLY

日標遙控及電子設備

Receiver (7-channel or more)  
接收器 (七頻以上)or  
或Remote receiver  
衛星接收Transmitter  
(7-channel or more, helicopter system)  
發射器 (七頻以上直升機模式遙控器)Intelligent Balance Charger RCC-6CX  
智慧型平衡充電器 RCC-6CX22.2V 6S 2600-5200mAh  
Li-Po Battery x 2 pcs  
22.2V 6S 2600-5200mAh Li-Po 電池 x 2

## ADDITIONAL TOOLS REQUIRED FOR ASSEMBLY 自備工具

Swashplate Leveler  
十字調整器Digital Pitch Gauge  
電子傾角規Multi-function Tester  
Voltmeter/Servo Diagnosis  
多功能測試  
電壓電阻/伺服器檢測Phillips Screw Driver  
十字螺絲起子  
φ 3.0V φ 1.8mmCutter Knife  
刀子Hexagon Screw Driver  
六角螺絲起子  
4mm/3mm/2.5mm  
2mm/1.5mmNeedle Nose Pliers  
尖嘴鉗Oil  
潤滑油CA  
瞬時膠

## 4. PACKAGE ILLUSTRATION 包裝說明

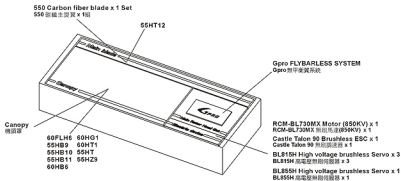



## CAREFULLY INSPECT BEFORE REAL FLIGHT 請嚴密執行飛行前之檢查義務

- Before flying, please check to make sure no one else is operating on the same frequency for the safety.
- Before flight, please check if the batteries of transmitter and receiver are enough for the flight.
- Before turn on the transmitter, please check if the throttle stick is in the lowest position. IDLE switch is OFF.
- When turn off the unit, please follow the power on/off procedure. Power ON- Please turn on the transmitter first, and then turn on receiver. Power OFF- Please turn off the receiver first and then turn off the transmitter. Improper procedure may cause out of control, so please to have this correct habit.
- Before operation, check every movement is smooth and directions are correct. Carefully inspect servos for interference and broken gear.
- Check for missing or loose screws and nuts. See if there is any cracked and incomplete assembly of parts. Carefully check main rotor blades and rotor holders. Broken and premature failures of parts possibly cause resulting in a dangerous situation.
- Check all ball links to avoid excess play and replace as needed. Failure to do so will result in poor flight stability.
- Check if the battery and power plug are fastened. Vibration and violent flight may cause the plug loose and result out of control.
- 每次飛行前應先確認所使用的頻率是否會干擾他人，以確保您自身與他人的安全。
- 每次飛行前請先確認發射器與接收器電池的電量是在足夠飛行的狀態。
- 開機前請確認油門桿桿是否位於最低點，熄火降溫開關，定速開關 (IDLE) 是否於關閉位置。
- 開機時必須遵守電源開關機的程序，開機時應先開啟發射器後，再開啟接收器電源；關機時應先關閉接收器後，再將發射器電源關閉。不正確的開機程序可能會造成失控的現象，影響自身與他人的安全，請養成正確的习惯。
- 開機前請先檢查所有機械的動作是否順暢，及方向是否正確，並檢查有關零件是否有干涉或磨損的情形，使用故障的零件將導致不可預期的危險。
- 飛行前請確認沒有缺少或鬆動的螺絲與螺帽，確認沒有組裝不完整或磨損的零件，仔細檢查主旋翼是否有損壞，特別是接近主旋翼夾座的部位，損壞或組裝不完整的零件不僅影響飛行，更會造成不可預期的危險。注意：每次飛行前的安全檢查、保養、及更換損耗零件，請確實嚴格執行以確保安全。
- 檢查所有的連接桿是否有鬆動的情形，過鬆的連接桿應先更新，否則將造成直昇機無法操控的危險。
- 確認電池及電源插頭是否固定牢固，飛行中的震動或激烈的飛行，可能造成電源接觸點鬆脫而造成失控的危險。

## STANDARD EQUIPMENT 標準配備

 55HC4	 60FLH6	 55HB9	 55HB10	 55HB11
 60HB6	 60HQ1	 60HT1	 55HT	 55HZ8
 55HT12	 550 Carbon Fiber Blade 550 碳纖維主旋翼		 Castle Talon 90 無刷電子速度機 x 1	 Gpro 無主旋翼系統
 D6FF 金屬伺服器臂 x 3 BL81EH High voltage brushless Servo x 3 BL81EH 高電壓無刷伺服器 x 3	 BL85SH High Voltage Brushless Servo x 1 BL85SH 高電壓無刷伺服器 x 1		 M4x4 止鎖螺絲 x 1 Motor Pinion Helical Gear 16T x 1 馬達齒輪 16T x 1	 RCM-BL730MX Motor (850KV) x 1 無刷馬達 x 1

When you see the marks as below, please use glue or grease to ensure flying safety.

標有以下符號之組裝步驟，請配合上膠或上油，以確保使用之可靠度。

- CA : Apply CA Glue to fix.
- AB : Apply AB Glue to fix.
- R48 : Apply Anaerobics Retainer to fix.
- T43 : Apply Thread Lock to fix.
- OIL : Add Grease.

- CA : 使用瞬間膠固定
- AB : 使用 AB 膠固定
- R48 : 使用金屬管狀固定鎖氣膠固定
- T43 : 使用螺絲膠
- OIL : 添加潤滑油

When assembling ball links, make sure the "A" character faces outside.

各項塑膠組裝連接桿時，A 字請朝外。



R48 metal tubular adhesive (eg. Bearings). T43 Thread lock, apply a small amount on screws or metal parts and wipe surplus off. When disassembling, recommend to heat the metal joint about 15 Seconds. (NOTE : Keep plastic parts away from heat.)

R48 為強力金屬管狀(如軸承)接著劑，T43 為螺絲膠，膠合螺絲或金屬內外徑請務必少量使用，必要時請用于去除多餘膠量，拆卸時可於金屬接合部位加熱約 15 秒。(注意：塑膠件避免接近熱源)

## 60FLH6



**Already assembled by Factory.**  
 Before flying, please check if the screws are fixed with glue.  
 廠裝零件或成品，每一次飛行前請先確認該零件是否已上膠不會鬆動。

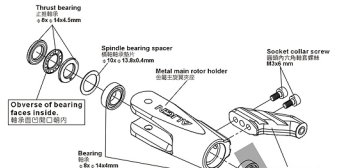

**Thrust bearing and washer for radial bearing are wear items, and thus should be inspected for replacement after every 20 flights.**  
 For flights with high headspeed, the inspection interval should be reduced to ensure flight safety.  
 止推軸承及橫軸軸承屬於飛行消耗品，建議每 20 個定額檢查及更換。高主旋翼轉速飛行時，請縮短定額檢查之週數，以確保飛行安全。



**Apply grease on thrust bearing.**

止推軸承塗上潤滑油

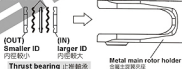

## 60FLH6

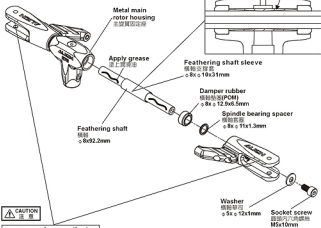
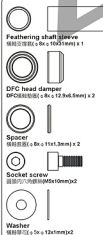

## 55FLH6

**Linkage ball B (M3x4)**  
 球頭球(M3x4) (ø 5x12mm) x2

**Linkage ball D (M3x3.5)**  
 球頭球(M3x3.5) (ø 5x8.3mm) x2

**Long linkage ball (M3x4)**  
 帶帽長球頭球(M3x4)  
 (ø 5x29mm) x1

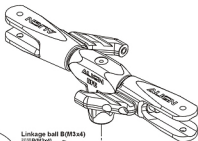

**Linkage ball B (M3x4)**  
 球頭球(M3x4)  
 (ø 5x12mm)

球頭球(M3x4)  
 (ø 5x12mm)

**Linkage ball D (M3x3.5)**  
 球頭球(M3x3.5)  
 (ø 5x8.3mm)

**DFC CCPM Swashplate**  
 DFC CCPM 十字盤

**Long linkage ball (M3x4)**  
 帶帽長球頭球(M3x4)  
 (ø 5x29mm)

Apply a little amount of T43 thread lock when fixing a metal part.  
 螺絲鎖附於金屬件請使用適量T43(螺絲膠)



**Already assembled by Factory. Before flying, please check if the screws are fixed with glue.**

機架裝架完成後，每一次飛行前請先確認螺絲是否已上膠不會鬆動。

**When tightening a screw to a plastic part, please tighten it firmly, but not over tightened, or they will strip.**

螺絲鎖入塑膠件請務必注意，適當扭力鎖緊即可，過度鎖緊的扭力可能會導致毀傷。

## 60FLH4A

**Bearing**  
 軸承 (ø 3xø 7x3mm) x4

**Washer**  
 墊圈 (ø 3xø 4.8x0.3mm) x2

**700DFC Collar**  
 700DFC 連桿套 (ø 8xø 4.8x0.3mm) x2

**700 DFC Linka rod(A)**  
 700 DFC 連桿A 85x14mm x2

**Socket screw**  
 圓頭六角扁頭螺絲 (M3x8mm) x1

**M3 Nut**  
 M3螺絲帽 x1

**Socket collar screw**  
 圓頭六角扁頭螺絲 (M3x15mm) x1

**Socket collar screw**  
 圓頭六角扁頭螺絲 (M3x15mm) x2

## 60FLH6

**Elevator ball link**  
 升降機連桿 x2

**Socket collar screw**  
 圓頭六角扁頭螺絲 (M3x8mm)

**Socket collar screw**  
 圓頭六角扁頭螺絲 (M3x8mm)

**Washer**  
 墊圈 (ø 3xø 4.8x0.3mm)

**Main rotor griplinkage bearing sleeve**  
 主旋翼連桿軸套 (ø 3xø 4.8x5mm)

**Main rotor grip arm integrated control linkage**  
 主旋翼連桿集成控制連桿 (ø 3xø 11x17.2mm)

**700 DFC Linka rod(A)**  
 700 DFC 連桿(A) 85x14mm

**700 DFC Collar**  
 700 DFC 連桿套 (ø 8xø 4.8x0.3mm)

**Elevator ball link**  
 升降機連桿

**M3 Nut**  
 M3螺絲帽

**Head stopper**  
 旋翼頭止動套

**Socket screw**  
 圓頭六角扁頭螺絲 (M3x8mm)

**Socket collar screw**  
 圓頭六角扁頭螺絲 (M3x15mm)

**Socket collar screw**  
 圓頭六角扁頭螺絲 (M3x15mm) x2

**Socket collar screw**  
 圓頭六角扁頭螺絲 (M3x15mm) x2

**Socket collar screw**  
 圓頭六角扁頭螺絲 (M3x15mm) x2

**Socket collar screw**  
 圓頭六角扁頭螺絲 (M3x15mm) x2

**Socket collar screw**  
 圓頭六角扁頭螺絲 (M3x15mm) x2

**Socket collar screw**  
 圓頭六角扁頭螺絲 (M3x15mm) x2

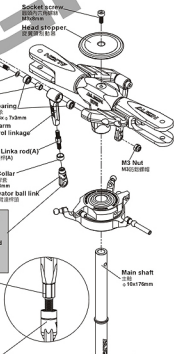

**Make sure the linkage rod A is completely fastened with main rotor grip arm integrated control link and apply a little amount of R48 thread lock to avoid any vibration and loose fitted during flight and cause it breaks.**

連桿A鎖入主旋翼連桿集成控制連桿時請務必使用適量R48鎖膠，避免飛行中的震動及鬆動，嚴重可能導致飛行中斷裂。

**You may adjust the length of ball link when tracking is off while flight.**

飛行中的偏航情形，可適當調整連桿長短改善。

## 55HB10



Socket collar screw  
圓頭內六角軸套螺絲 (M3x8mm) x 4



Socket collar screw  
圓頭內六角軸套螺絲 (M3x8mm) x 16



Socket screw  
圓頭內六角螺絲 (M3x8mm) x 2



Bearing  
軸承 (φ 10x φ 19x5mm) x 2



Bearing  
軸承 (φ 6x φ 12x4mm) x 1



DFC canopy mounting bolt  
DFC機罩固定螺栓  
6 x 14.5mm x 4



Socket button head screw  
半圓頭內六角螺絲 (M3x8mm) x 2

## 55HZ8



Socket screw  
圓頭內六角螺絲 (M4x10mm) x 4



M4 Washer  
M4華司 (φ 4x φ 8x1mm) x 4



M4 Set screw  
M4止退螺絲 (M4x4mm) x 2

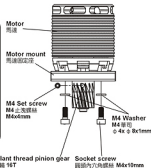

注意

Motor  
馬達

Motor mount  
馬達固定座

M4 Set screw  
M4止退螺絲  
M4x4mm

M4 Washer  
M4華司  
φ 4x φ 8x1mm

Motor slant thread pinion gear  
馬達斜齒輪 16T

Socket screw  
圓頭內六角螺絲 M4x10mm

Make sure the motor mount is fully fastened before fasten the motor pinion gear mount.  
先將馬達固定座完全裝緊固定後，再將馬達斜齒輪裝緊。

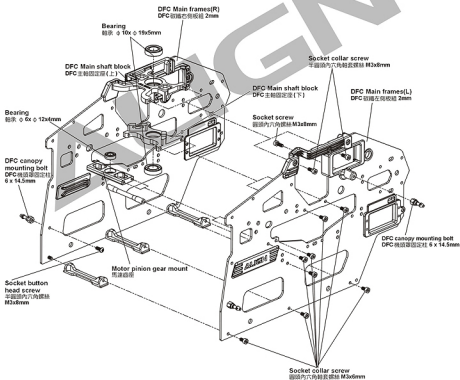

Apply a little amount of T43 thread lock when fixing a metal part.  
螺絲鎖附於金屬件請使用適量 T43(螺絲膠)



### Main frame assembly key point :

First do not fully tighten the screws of main frames and put two bearings through the main shaft to check if the movements are smooth. The bottom bracket must be firmly touched the level table top(glass surface) : please keep the smooth movements on main shaft and level bottom bracket, then slowly tighten the screws. This assembly can help for the power and flight performance.

#### 機身側板組立重點：

安裝螺絲先不完全鎖緊，放入主軸貫穿兩顆軸承並上下移動必能滑順，主體底板必須與水平桌面(玻璃平面)緊密緊貼；請保持主軸滑順與底板平行桌面後慢慢鎖緊螺絲，正確側板的組裝對動力與飛行性能有著著幫助。

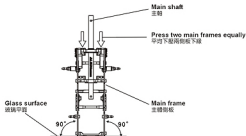

### 55HG1A



### 55HB10



### 55HB10A



### 55HB11

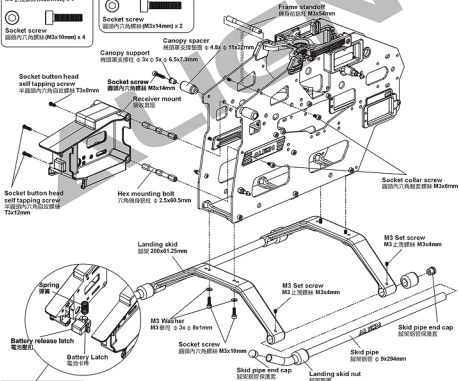

Battery release latch installation illustration  
電池卡扣安裝示意圖

Apply a little amount of T43 thread lock when fixing a metal part.  
螺絲鎖附於金屬件請使用適量 T43 (螺絲膠)

## 55HZ11



Linkage ball C(M2x4)  
球頭 C(M2x4) (φ 5x5mm) x 1



Linkage ball C(M2x4)  
球頭 C(M2x4) (φ 5x12mm) x 2



Socket button head self tapping screw  
半圓頭內六角自攻螺絲 (T2.6x12mm) x 4

## 55HB10



Socket button head screw  
半圓頭內六角螺絲 (M2.5x10mm) x 8

Apply a little amount of T43 thread lock when fixing a metal part.  
螺絲鎖付於金屬件時使用適量 T43 螺絲膠)

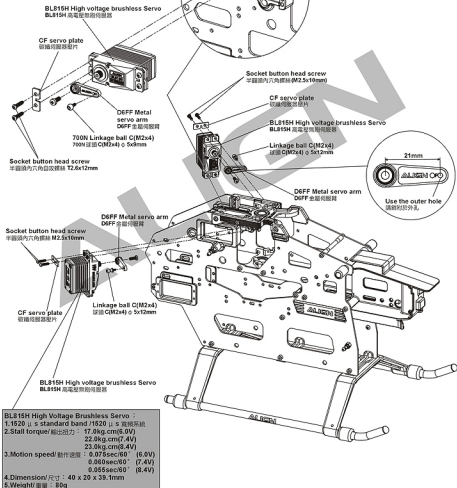

**55HB10**

Socket button head collar screw  
半圓頭內六角扁頭螺絲(M3x3mm) x 4

**55HZ11**

Linkage ball A(M2x3.5)  
環頭A(M2x3.5) (φ 4.75x8.18mm) x 1



M2 Nut  
M2 螺帽 x 1  
Socket button head self tapping screw  
半圓頭內六角扁頭自攻螺絲(T2.6x12mm) x 4

Recommend sanding the marked position as below illustration with a waterproof abrasive paper(#800-1000) to avoid the wires of electric parts to be cut.  
建議於下面色塊標示處，使用#800-1000水砂紙打磨，可防止電子設備電線被刮破。



Waterproof abrasive paper  
水砂紙



**Make sure the motor mount is fully fastened before fasten the motor pinion gear.**  
先將馬達固定座鎖緊固定後，再將馬達齒座鎖緊。

**While assembling the motor mount, please make sure to properly loose M4 Set screw on 16T motor gear first, after fully fasten the motor mount with the motor pinion, then fasten back the M4 Set screw completely.**  
安裝馬達齒座時，請先將 16T 馬達齒座上的 M4x4mm 止咬螺絲鎖鬆後，當馬達齒座固定和馬達齒座固定好後，再將馬達止咬螺絲鎖緊。

- BL855H High Voltage Brushless Servo :**
- 1. 1520 μs standard band / 1520 μs 寬頻系統
  - 2. Stall torque / 輸出扭力: 8.0kg.cm(8.0V)  
10.0kg.cm(7.4V)  
12.5kg.cm(8.4V)
  - 3. Motion speed / 動作速度: 0.04sec/60° (8.0V)  
0.03sec/60° (7.4V)  
0.028sec/60° (8.4V)
  - 4. Dimension / 尺寸: 40 x 20 x 39.1mm
  - 5. Weight / 重量: 73g

Servo extension cable  
伺服延長線



For extend the rudder servo signal cable.  
用於伺服訊號線延長應用

BL855H High voltage brushless Servo  
BL855H 高電壓無刷伺服馬達



3K CF servo plate  
3K 伺服角鋼板型片

Socket button head self tapping screw  
半圓頭內六角扁頭自攻螺絲(T2.6x12mm)



**Please trim away the other servo horns, and fasten linkage ball on the outer second hole.**  
請先將原附十字舵角片切掉多餘的另外三處，並將球頭鎖附於外側第二孔。

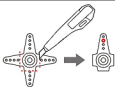

Motor  
馬達

Motor Mount  
馬達固定座

Socket button head collarscrew  
半圓頭內六角扁頭螺絲(M3x3mm)

Linkage ball A(M2x3.5)  
環頭A(M2x3.5) (φ 4.75x8.18mm)

## 60HT1

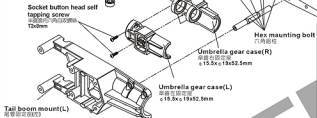
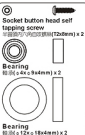

Apply a little amount of T43 thread lock when fixing a metal part.  
螺絲鎖對於金屬件請使用適量T43(或螺絲膠)

CAUTION  
注意

Already assembled by Factory. Before flying, please check if the screws are fixed with glue.

原廠組裝完成品，每一次飛行前請先確認螺絲是否已上膠不會鬆動。

When tightening a screw to a plastic part, please tighten it firmly, but not over tightened, or they will strip.

螺絲鎖入塑膠件請務必以適量，適當扭力旋緊即可，而過緊的扭力可能會導致滑牙。

CAUTION  
注意



Already assembled by Factory. Before flying, please check again if screws are firmly secured and applied with some glue.

原廠組裝完成品，飛行前務必再次確認螺絲是否鎖緊上膠。

## 60HT6

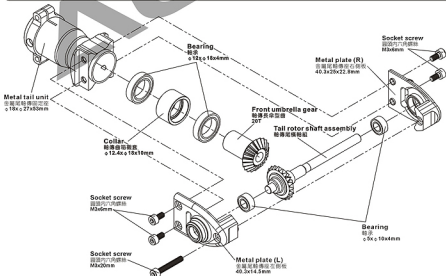



## 60HT6

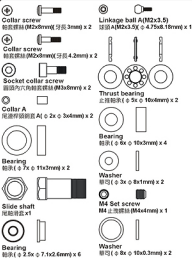

## 55HT11



Apply a little amount of T43 thread lock when fixing a metal part.  
螺絲鎖於金屬件請使用適量 T43 (鎖綠膠)



CAUTION  
注意

Apply grease on thrust bearing.  
止推軸承塗上潤滑脂



Smaller ID larger ID Tail rotor holder  
內徑較小 內徑較大 尾座固定套

THRUST BEARING 止推軸承

While assembly the slide shaft, please use suitable amount of T43 on the thread. Please do not use R48 anaerobics retainer or other high strength glue to avoid damages while maintenance or repairs.

組立尾座滑套時，請使用適量的T43螺絲鎖膠在螺絲上，嚴禁使用R48低膠合性軸承鎖膠或防鬆膠，以免日後拆裝時損壞零件之損傷。



Assembling Umbrella Gear: Please note to push the gear to the end at a fixed position, to make sure the gears mesh with each other smoothly.  
安裝組裝：注意務必將齒推到底定位，以避免齒咬合不順暢。

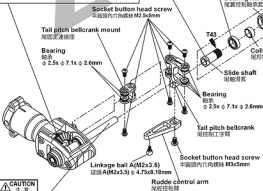

CAUTION  
注意

Aim tail rotor hub at the concave of tail rotor shaft and fix it, please apply a little glue on the set screw.  
尾座與 T 型尾座尾座螺絲的凹形並鎖上，請確認止流螺絲上膠。

尾座與 T 型尾座尾座螺絲的凹形並鎖上，請確認止流螺絲上膠。

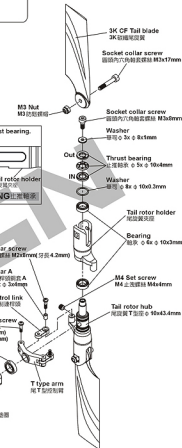

CAUTION  
注意

After complete the tail rotor assembly, please check if it rotates smoothly.  
尾座與尾座組裝完成後，需確認尾座翼固定座轉動順暢。

When assembling into the tail boom, please apply some oil on the surface, to make it smooth during the assembling and keep it vertical with the torque tube for smooth rotation.

插入尾管內的，外表抹些潤滑油，以確保平滑型入尾管中並與尾傳動軸保持垂直，讓尾輪帶動順暢。

Already assembled by factory, please note to check again. 已組裝完成，請務必再檢查。

When assembling the tail boom, please aim at the fixing hole  $\phi 5.1$  裝入尾管時請注意孔的專用 $\phi 5.1$ 固定孔。

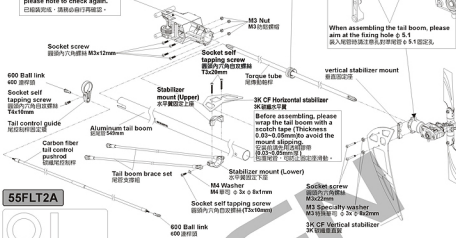

### 55FLT2A

Bearing 軸承  $\phi 8 \times \phi 14 \times 4mm$  x 2

### 60HT1A

Socket screw 鑿孔內六角螺絲 (M3x12mm) x 4

M3 Nut M3 防松螺帽 x 4

### 60HT6

Socket collar screw 鑿孔內六角自攻螺絲 (M3x22mm) x 2

M3 Specialty washer M3 特殊墊圈  $\phi 3 \times \phi 8 \times 2mm$  x 2

### 55HT3A

M3 Washer M3 墊圈  $\phi 3 \times \phi 8 \times 1mm$  x 2

Socket self tapping screw 鑿孔內六角自攻螺絲 (T3x10mm) x 2

### TIP TO FIX THE TORQUE TUBE 傳動軸軸承固定位置

Please apply some CA glue to fix bearing on the torque tube, avoid CA glue from the dust or may cause the bearing stuck. When assembling into the tail boom, please apply some oil and use the attached torque tube mount helper to press the bearing holder of the torque tube into the tail boom horizontally.

請以少量 CA 將軸承固定於尾傳動軸上，避免 CA 沾到軸承的防塵蓋而導致軸承卡死，插入尾管內的，尾傳動軸承墊圈外表抹些潤滑油，利用隨軸承安裝套安裝將尾傳動軸承墊圈水平壓入尾管中不可歪斜。

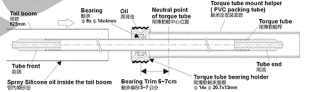

### 55HT12

Ball link 600 滾桿 x 2

Socket self tapping screw 鑿孔內六角自攻螺絲 (T3x26mm) x 2

CAUTION 注意

Skewed Torque Tube bearing holder will interfere with torque tube rotation and cause unusual vibration. 尾傳動軸承非安裝正位會造成傳動軸運轉不順及尾節異常震動等問題。

CAUTION 注意

After moving the tail control rod adjustment sleeve to recommended position, glue the sleeve to carbon tail control rod with instant glue. 尾控制桿調整環調整到建議位置後，再將尾控制桿調整環與碳纖維尾控制桿粘貼固定以確保調整位置穩定。

Apply a little amount of T43 thread lock when fixing a metal part.  
 螺絲鎖附於金屬件請使用適量 T43 (鎖結膠)

### 55HB10A

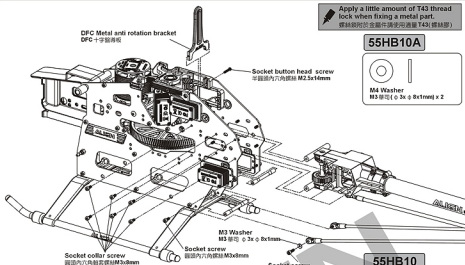

### 55HB10

#### 60HT6

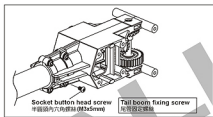

### 60HB6

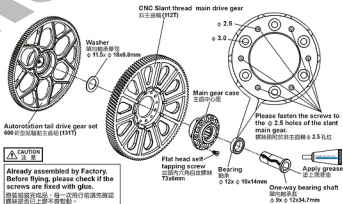

**CAUTION**  
 Already assembled by Factory.  
 Before flying, please check if the screws are fixed with glue.  
 螺絲鎖裝完成品。每一架飛行前請先確認螺絲是否已上膠不會鬆動。



Before tightening the screw, please rotate the bearing and check the concentricity of the bearing in order to have the screw firmly secured, to avoid the bearing stuck or heavy load at one side and cause slip.  
 上緊螺絲前請先轉動齒輪並向心度良好後，才能將螺絲平均鎖緊，以免先造成卡死或偏向重負載可能產生的打滑。

Apply a little amount of T43 thread lock when fixing a metal part.  
螺絲鎖附於金屬件請使用適量 T43 螺絲膠

When tightening the main blade fixing screw, please tighten it firmly, but not over tighten, or it may cause the damage of main blade holder and result in danger.

鎖緊主旋翼螺絲時請適量鎖緊即可，過緊可能導致主旋翼夾座受損，飛行意外發生。

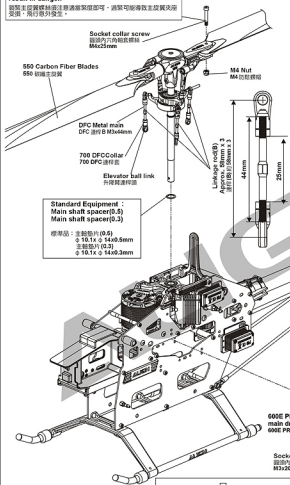

## 60FLH4A

### Main Blade Fixing Screw

鎖主旋翼用螺絲

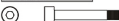

### Socket collar screw

螺絲內六角鎖緊螺絲 (M4x25mm) x 2



M4 Nut  
M4 尼龍螺帽 x 2

## 700FLZ7

### Elevator ball link

升降舵連杆套 x 6

### 700 DFC Collar

700 DFC 連杆套 x 6

### DFC Linkage rod (B)

DFC 連杆 (B) (M3x44mm) x 3

### Linkage rod (B)

連杆 (B) 1/58mm x 3

### Swashplate Leveler

十字型調整器

### Main shaft

主軸

### Horizontally Level

水平

### Swashplate

十字盤

### CAUTION

注意

### While using Gpro Flybarless system, please use the swashplate leveler to calibrate swashplate. Adjust the length of servo linkage rod to make sure the swashplate is leveled before start setting up Gpro to ensure Gpro provides the best performance.

使用 Gpro 無平衡系統，請務必使用十字型調整器校正十字盤，調整伺服連杆長度，確保十字盤達到水平狀態，再進行 Gpro 基本機體設定，這樣才能確保 Gpro 飛行性能達到最佳效果。

## 60HB6

### Socket collar screw

螺絲內六角鎖緊螺絲 (M3x20mm) x 1

### M3 Nut

M3 尼龍螺帽 x 1



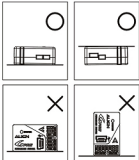

1. Consult the following diagram for Gpro installation direction, with arrow pointing toward nose or tail of helicopter. Gpro needs to be mounted flat on gyro mounting platform, away from vibration sources.
2. Two pieces of foam mounting tape can be used if helicopter experiences vibration induced flight instability. However, if this still doesn't cure the problem, please check the helicopter mechanics and minimize mechanical vibrations, or reduce the headspeed.
3. Please secure with genuine factory issued double sided anti-vibration mounting tape.

1. Gpro 擺放方向請參照圖示，方向標示箭頭指向機頭或機尾，水平擺放於陀螺儀固定座，並避開震動源。
2. 機體震動會影響陀螺儀感測，造成飛行不穩定，可於 Gpro 下方貼附 2 片海棉減震，若仍未改善，請檢查機體排除震動或降低主旋翼轉速。
3. 請使用原廠提供避震泡棉雙面膠固定。

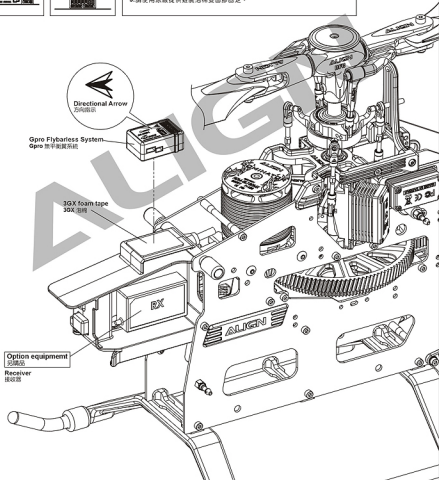

**CAUTION**  
注意

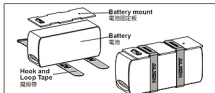

Please fix the battery on the battery mount evenly.  
電池請平均固定於電池板上。

**CAUTION**  
注意

Slide the battery mounting plate along the rail until a "click" is heard to make sure the battery mounting plate is latched.  
將電池固定板沿著電池滑軌裝入至發出“喀嗒”聲響，使電池固定板卡入卡榫。

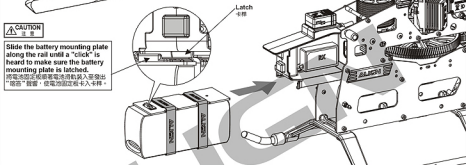

Press this latch to allow the battery to slide out along the rail.  
電池取出時請先將電池壓到往內壓，順著滑軌取出。

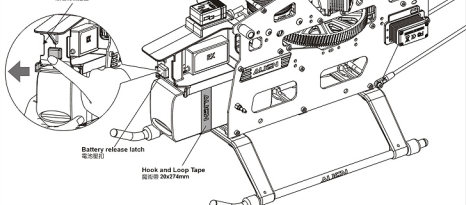

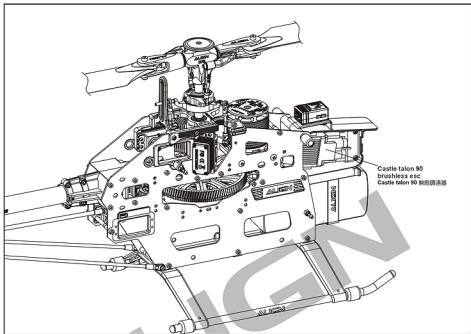

## 10. CANOPY ASSEMBLY 機頭罩安裝

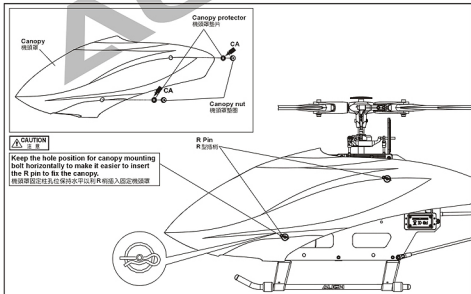

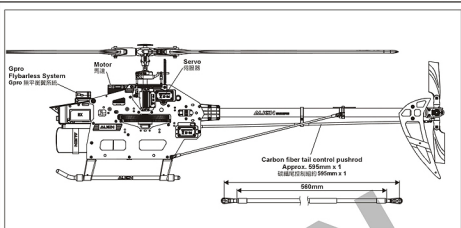

## PARTS IDENTIFICATION 各部位名稱

## Gpro FLYBARLESS SYSTEM Gpro 無平衡翼系統

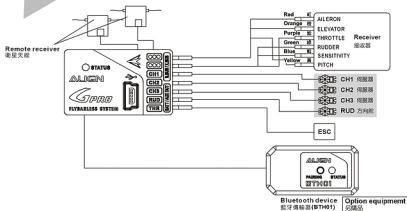



To set this option is to turn on the transmitter and connect to BEC power.

**Note:** For the safety, please do not connect ESC to the brushless motor before the setting in order to prevent any accident caused by the motor running during the setting.

此項設定只要開啟發射器，插上BEC電源即可進行操作。

注意：為了安全起見，設定前請先不要將無刷馬達與無刷馬達三線線路上，以免調整時啟動馬達而發生危險。

### SERVO CONFIGURATION 伺服器配置

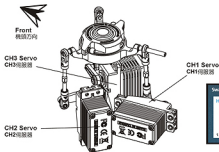

1. Following the servo configuration diagram on left, plug the servo to Gpro.
  2. When setting up Gpro, select swashplate type HR-3, 120 degrees CCPM in the PC interface as shown below. For more details please refer to page 22 in flybarless system manual.
- 1.請依照左圖顯示的伺服器名稱，將伺服器接到Gpro。  
2.設定Gpro時，電腦設定介面的十字鍵類型請選擇HR-3，120度CCPM，如下圖所示。可參考P22頁無刷平衡系統使用說明。



### 13. ADJUSTMENTS FOR GYRO AND TAIL NEUTRAL SETTING 陀螺儀與尾翼中立點設定調整

Turn off Revolution mixing(RVMX) mode on the transmitter, then set the gain switch on the transmitter and the gyro to non-Head lock mode, or disable gain completely. After setting the transmitter, connect the helicopter power and proceed with rudder neutral point setting. Note: When connecting to the helicopter power, please do not touch tail rudder stick and the helicopter, wait for 3 seconds for gyro to enable, and the rudder servo horn should be 90 degrees to the tail servo. Tail pitch slider should be half way on the tail output shaft. This will be the standard rudder neutral point. After completing this setting, set the gain switch back to heading lock mode, with gain at around 70%.

發射器內陀螺儀設定請關閉旋轉混合模式，並將發射器上的增益開關與陀螺儀切至“非鎖定模式”或將陀螺儀增益關閉。發射器設定完成後接上直升機電源，即可進行尾舵中立點調整。注意：當接上直升機電源時請勿碰觸尾舵桿或直升機機身，待3秒陀螺儀啟動完成後，尾舵桿與尾舵伺服器的角度為90度，尾翼翼控制組滑杆置於尾翼輸出軸的中間位置，即為標準尾舵中立點設定。設定完成後，切換至“鎖定模式”，增益約70%左右。

#### TAIL NEUTRAL SETTING 尾中立點設定

After the gyro is enable and under non-Head lock mode, correct setting position of tail servo and tail pitch assembly is as photo, if the tail pitch assembly is not in the middle position, please adjust the length of rudder control rod to trim.

陀螺儀開啟後，在非鎖定模式下，尾舵與尾Pitch控制組正確擺置位置，若尾Pitch控制組未置於中間請調整尾舵桿的長度來修正。

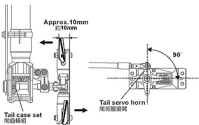

#### HEAD LOCK DIRECTION SETTING OF GYRO 陀螺儀鎖定向設定

To check the head lock direction of gyro is to move the tail clockwise and the tail servo horn will be trimmed counterclockwise. If it trims in the reverse direction, please switch the gyro to "REVERSE".

陀螺儀鎖定向確認，當手搖尾舵時機身轉動，尾舵桿應反時鐘修正，反向時請切換陀螺儀上“鎖定反向”開關修正。



## GENERAL FLIGHT 一般飛行模式



Stick position at high/Throttle 100%/Pitch+12°  
 選擇高速/油門100%,Pitch+12°



Stick position at Hovering/Throttle 70%/Pitch+5°  
 選擇停滯/油門70%,Pitch+5°



Stick position at low/Throttle 0%/Pitch-2°-0°  
 選擇低速/油門0%,Pitch-2°-0°

GENERAL FLIGHT  
一般飛行模式

Throttle 油門	Pitch 螺距
5 100% High speed 100% 高速	+12°
4 85%	
3 60%~65% Hovering 60%~65% 停滯	+5°
2 40%	
1 0% Low speed 0% 低速	-2°-0°

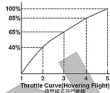

## Pitch and Rotation Speed Pitch與轉速關係

TIP: It is recommended to use a lower pitch setting when using higher RPM/Head speed. This will allow for better power. 設定要領: 如果應用較高轉速而應用動力螺距設定較高 Pitch, 將會導致扭力效能。

## 3D FLIGHT 3D特技飛行模式



Stick position at high/Throttle 100%/Pitch+12°  
 選擇高速/油門100%,Pitch+12°

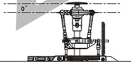

Stick position at middle/Throttle 90%/Pitch 0°  
 選擇中速/油門90%,Pitch 0°



Stick position at low/Throttle 100%/Pitch-12°  
 選擇低速/油門100%,Pitch-12°

## IDLE 1: SPORT FLIGHT

Throttle 油門	Pitch 螺距
5 100%	+10°~+12°
4 75%	
3 70%	+5°
2 75%	
1 80%	-5°

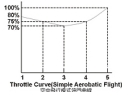

## IDLE 2: 3D FLIGHT

Throttle 油門	Pitch 螺距
5 100% High 100% 高	+12°
3 85% Middle 85% 中	0°
1 100% Low 100% 低	-12°

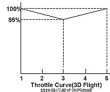

- Pitch range: Approx.  $\pm 15^\circ$ .
- If the pitch is set too high, it will result in shorter flight duration and poor motor performance.
- Setting the throttle to provide a higher speed is preferable to increasing the pitch too high.

- 螺距(Pitch)總行程約  $\pm 15^\circ$ 。
- 螺距設定太高, 會導致動力與飛行時間降低。
- 動力提升以較高轉速的設定方式, 優於螺距過大的設定。

## FEATURES 產品特色

- 3Axis** 3-axis gyroscopic flybarless system to simulate the stability of mechanical flybar system, yet at the same time achieving agile 3D performance.  
3軸陀螺儀無平衡翼系統，可模擬具有平衡翼系統的穩定性，更有靈活3D性能。
- MEMS** Utilizes MEMS gyro sensors, which feature small footprint, high reliability, and excellent stability.  
採用MEMS (Micro Electro Mechanical Systems) 微機電系統技術感測器，具有體積小、可靠性高、穩定性佳的優點。
- 12bit** Sensor with 12 bit ultra high resolution, resulting in highly precise controls.  
感測器12位元，超高解析度，控制精確精準。
- CPU** Brand new CPU processes 20 times faster than previous generation.  
CPU效能提升，速度提升20倍。
- Blue Tooth** Utilizes with Bluetooth for phone setup adjust.  
支援藍牙功能，可透過手機設定調整。
- iOS** Utilizes with iOS APP for instant adjustment  
支援iOS手機app調整功能。
- Android** Utilizes with Android APP for instant adjustment  
支援Android手機app調整功能。
- SPEKTRUM** Supports SPEKTRUM and JR satellite receivers.  
支援SPEKTRUM與JR衛星天線。
- S.BUS** Supports Futaba S.BUS architecture.  
支援Futaba S.BUS功能。
- X.BUS** Supports JR X.BUS architecture.  
支援JR X.BUS功能。
- PC** Software upgradable through PC interface adapter.  
具備可升級程式化介面，可透過傳輸線更新軟體。
- Energy** Flybarless system dramatically improves 3D power output and efficiency, resulting in reduced fuel or electricity consumption.  
無平衡翼系統，可大降強3D大動作飛行能量消耗，提供直昇機更大的動力輸出且更加節省燃油或電力。
- Stable** Highly sensitive gyroscopic sensors combined with advanced control routine providing higher hovering and aerobatic stability than other flybarless system.  
高感度陀螺儀感測器及先進演算法設計，可提供比一般平衡翼系統更佳的靜態及動態穩定性。
- CCPM** Suitable for all CCPM and mechanical mixing system.  
適用於任何比例之對稱式三伺服器CCPM系統及傳統十字盤系統。
- GOV** Built in speed governor function.  
內建速度穩定器功能。
- 3.5V-8.4V** Compatible with heli-copter of all sizes from T-REX 250 to T-REX 800.  
Gpro Flybarless電子設備相容四小型直昇機至大型直昇機T-REX250~T-REX800。
- 3.5V-8.4V** Capable to operate between 3.5V to 8.4V, compatible with high voltage servos.  
適用電壓3.5V~8.4V，支援高電壓伺服器。
- Small** Small footprint, light weight, minimalist and reliable design.  
體積小、重量輕、構造簡單可靠，提供操控者高性能的飛行樂趣。

## SETUP PRE-CHECK 設定前注意事項



While using Gpro FBL system, be sure to turn off the following functions in the transmitter  
使用Gpro系統若是遙控器有下列功能時請勿開啟功能

★ Swash AFR ★ Linkage Compensation ★ Swash Mix ★ Mixing ★ Acceleration

1. Connect the receiver and servos to the Gpro Flybarless system unit as per diagram found on page 23 ~ 24 .
  2. Digital servos must be used on cyclic to avoid damage to servos.  
Recommended servo spec: minimum speed 0.08 sec/60 degrees, torque 12kg.cm or higher.
  3. Prior to first use, please enter setup program through helicopter's Hardware Setup menu, followed by parameter tuning in each tab, then concludes with flight parameter menu settings. Please ensure helicopter's hardware settings has been completed before making changes to flight parameters.
  4. Before entering setup mode, all trims on transmitter need to be zeroed. Do not adjust the trim tab while flying. If helicopter experiences drifting during hover, this is an indication that swashplate was not leveled during setup. Should this occur, please enter the flybarless system "swashplate settings" mode, adjust the level of swashplate, and then complete the setup again.
  5. Please unplug motor wires or activate throttle HOLD when performing Gpro configuration. After completing setup, remember to power Gpro back on.
  6. Please be sure to disconnect the USB cable and re-power your Gpro after connection with the desktop app, otherwise Bluetooth connection will fail.
1. 將接收器及伺服器根據接線示意圖連接 (請參照第23~24頁)。
  2. 十字盤必須安裝數位伺服器，否則會造成伺服器損毀。建議規格：速度0.08秒/60度以內；扭力12kg.cm以上。
  3. 第一次安裝Gpro Flybarless無平衡翼系統時，請先進行"直昇機設定"，並選擇"建立全新設定"，且逐一設定完成所有直昇機設定。
  4. 進入設定前必須將遙控器的外圍調節等，飛行時不可調整外圍調。若直昇機停懸時偏向某一處移動，表示設定時十字盤未保持水平，重新完成設定。
  5. 進行Gpro設定時，請拔除馬達線或切到油門HOLD模式，才進行設定；設定完畢後，請重新開啟Gpro電源。
  6. 當Gpro與電腦連接時，Gpro會關閉藍牙連接功能，這是為避免使用者同時使用電腦與藍牙設定時，造成系統錯誤的保護措施。如果使用電腦設定後要馬上使用藍牙連接功能，請重新開啟Gpro電源，再進行藍牙設定。

## METHOD 1: STANDARD RECEIVER CONNECTIVITY METHOD 方式一:傳統接收器接線法

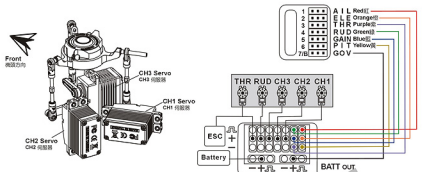

**CAUTION 注意** When connecting Gpro to the power supply, make sure the positive and negative electrode are correctly connected. If it's in opposite direction, the over current can cause serious damage to Gpro system.  
連接電源時，請注意正負極方向，接錯方向會導致您的Gpro燒毀。

1. Connect all wires as shown in diagram. Receiver and Gpro wires are color coded to distinguish the different connection channels. Care should be taken to ensure proper wire color to channel connection.
  2. While using the speed controller that not including BEC, you need to connect the BEC power with Gpro "BATT" port.
  3. Receiver power is achieved by connecting the Gpro "S.BUS/X.BUS" port to the ch7 or BATT port on receiver using supplied signal wire.
  4. To avoid damage to servos, only digital servos should be used for swashplate. Recommended spec: 0.08s/60 degrees or faster, with 12 Kg.cm or higher torque.
  5. Gpro has built in nitro governor function which require purchase of optional governor sensor.
1. 請依照圖示進行接線，接收器與Gpro的接線使用不同的顏色來區分不同的通道，接線時請注意各顏色所對應的通道。
  2. 使用無BEC輸出的调速器時，須另外由Gpro的"BATT"孔位接入BEC電源。
  3. 接收器電源須以隨附的訊號線由Gpro的"S.BUS/X.BUS"孔位接至第七通道或BATT通道。
  4. 十字槳必須安裝數位伺服器，否則會造成伺服器損毀。  
建議規格：速度0.08秒/60度以內；扭力12kg.cm以上。
  5. Gpro內建油機定速器功能，可見購定速器感知器使用。

## METHOD 2: FUTABA S.BUS &amp; JR X.BUS CONNECTIVITY METHOD 方式二:FUTABA S.BUS &amp; JR X.BUS接線法

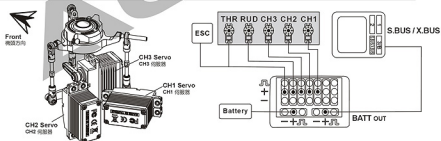

**CAUTION 注意** 1. When connecting to JR X.BUS, please select X.BUS "MODE A" in transmitter.  
2. When connecting Gpro to the power supply, make sure the positive and negative electrode are correctly connected. If it's in opposite direction, the over current can cause serious damage to Gpro system.  
1. 使用JR X.BUS接線時，遙控器請選擇X.BUS"MODE A"模式。  
2. 連接電源時，請注意正負極方向，接錯方向會導致您的Gpro燒毀。

1. For Futaba S.BUS and JR X.BUS receivers, connect wires as shown in diagram.
  2. While using the speed controller that not including BEC, you need to connect the BEC power with Gpro "BATT" port.
  3. Receiver power is supplied through S.BUS/X.BUS signal wire connected to Gpro's "S.BUS/X.BUS" port.
  4. To avoid damage to servos, only digital servos should be used for swashplate. Recommended spec: 0.08s/60 degrees or faster, with 12Kg.cm or higher torque.
  5. Gpro has built in nitro governor function which require purchase of optional governor sensor.
1. 具備S.BUS功能的Futaba接收器，請依照圖示進行接線。
  2. 使用無BEC輸出的调速器時，須另外由Gpro的"BATT"孔位接入BEC電源。
  3. 接收器電源須由S.BUS/X.BUS訊號線接至Gpro的"S.BUS/X.BUS"孔位。
  4. 十字槳必須安裝數位伺服器，否則會造成伺服器損毀。  
建議規格：速度0.08秒/60度以內；扭力12kg.cm以上。
  5. Gpro內建油機定速器功能，可見購定速器感知器使用。

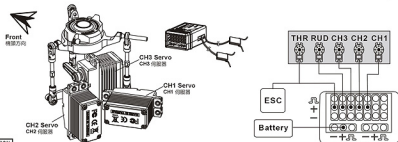

1. When binding, do not mix satellite receivers of different makes.
2. Incompatibility with future models of satellite receivers will be resolved through firmware updates.
3. When connecting Gpro to the power supply, make sure the positive and negative electrode are correctly connected. If it's in opposite direction, the over current can cause serious damage to Gpro system.

1. 不同廠牌的衛星天線請勿交叉對插。
2. 如有新型號衛星天線產生不相容情形，將以軟體更新方式解決。
3. 連接電源時，請注意正負極方向，反插方向會導致您的Gpro損毀。

1. For JR or SPEKTRUM satellite receivers, connect wires as shown in diagram.
2. While using the speed controller that not including BEC, you need to connect the BEC power with Gpro "BATT" port.
3. To avoid damage to servos, only digital servos should be used for swashplate. Recommended spec: 0.08s/60 degrees or faster, with 12Kg.cm or higher torque.
4. Gpro has built in nitro governor function which require purchase of optional governor sensor.
5. For radios with less than 6 channels, channel 5/GEAR is used for rudder gyro gain. Speed governor cannot be used. For safety concern, two satellite receivers should be used, with each antenna perpendicular (90 degrees) from each other. A satellite receiver should be installed on each side of the frame, separate by minimum distance of 5cm.

1. 請依照圖示進行接線，Gpro支援SPEKTRUM與JR系統衛星天線。
2. 使用無BEC輸出的调速器時，須額外由Gpro的“BATT”孔位接入BEC電源。
3. 十字槳必須安裝數位伺服機，否則會造成伺服機損毀。  
建議規格：速度0.08秒/60度以內；扭力12kg.cm以上。
4. Gpro內建定速器功能，可另購定速器感知器使用。
5. 為安全起見，請盡量安裝兩個衛星天線，尚需衛星天線角度距必須呈90度之外，且須安裝於機身兩側，相隔至少5公分以上。

## BINDING PROCEDURE 對頻方式

Binding: (Hold last command)

對頻: (按住最後指令)

Binding with Failsafe: (Go to preset position)

對頻與失控保護: (回預設值)

Step 1: Connect power to Gpro, select the satellite receiver type and failsafe type.

Step 2: Re-connect power to Gpro, satellite receiver's LED will blink, indicating entering binding mode.

- 步驟1.將Gpro接上電源，選擇所使用的衛星天線及失控保護方式。  
步驟2.將Gpro重新接電，此時衛星天線LED燈會開始閃爍進入對頻狀態。

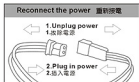

Please disconnect motor wires during binding to prevent dangerous unforeseen circumstances.  
對頻時請拔除馬達線，以免發生不可預期的危險。

- Step 3: Activate binding mode on your transmitter. Receiver LED will remain lit indicating successful binding.  
Note: In binding with failsafe mode, receiver's LED will go from fast blink to off immediately after successful binding, followed by slow blinks. Move the transmitter sticks to desired position to set the failsafe position, which will be confirmed with steady lit of LED after 5 seconds.

- 步驟3.將遙控器切換對頻模式，對頻完成衛星天線LED燈會恆亮。  
註：如果選擇“對頻與失控保護”，遙控器對頻完成瞬間，衛星天線上LED會由快速閃爍狀態熄滅，之後再亮起改為慢速閃爍狀態，將遙控器上的所有桿件置於您所需要的預設安全位置，5秒後LED燈會恆亮，完成對頻。



1. Please unplug motor wires or activate throttle HOLD when performing Gpro configuration.
2. Compatible with helicopter of all sizes from T-REX 250 to T-REX 800 Gpro Flybarless.

1. 進行Gpro設定時，請拔掉馬達線或切到油門HOLD模式，設定完畢後再重新開啟Gpro電源。  
2. Gpro Flybarless電子設備相容小型直昇機至大型直昇機T-REX 250~T-REX 800。

## 1. SELECT H-1 SWASHPLATE TYPE 遙控選擇 H-1 十字盤類型

When using Gpro, transmitter must be set to H-1 (1-Servo-Normal) traditional swashplate. Incorrect swashplate setting will cause setup problem and prevent helicopter from flying.

使用Gpro 遙控器必須選擇 H-1 (1-Servo-Normal)傳統十字盤。如果十字盤類型設定錯誤，會造成無法設定自動作不正確無法飛行。



PARAMETER	1 (1/3)
RESET	EXECUTE
TYPE	HELICOPTER
SWASH	H-1
REV	S-FHSS
ALT+	ON (1/25)

## 2. PC SOFTWARE INSTALL 電腦安裝軟體

Please go to <http://www.align.com.tw/Gpro/> to download and install Gpro PC software.

下載安裝Gpro電腦軟體請至下列網址下載安裝<http://www.align.com.tw/Gpro/>

Note: If you cannot setup the Gpro Windows version, please check whether you have installed the Microsoft .NET Framework 4.

<http://www.microsoft.com/en-US/download/details.aspx?id=17851>

註：無法安裝Gpro Windows版本時，請檢查電腦是否有安裝Microsoft .NET Framework 4。

<http://www.microsoft.com/zh-TW/download/details.aspx?id=17851>



## 3. LAUNCH THE PC SOFTWARE AND CONNECT TO Gpro 開啟電腦軟體並與Gpro連線

### STEP 1: LAUNCH PC SOFTWARE

#### 步驟1：開啓電腦軟體

After software is installed, double click Gpro software and proceed to connect your Gpro with mini USB cable.

軟體安裝完畢後，開啟Gpro軟體將mini USB線連接到Gpro。

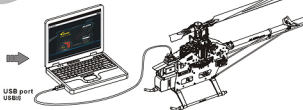

### STEP 2: POWER ON YOUR TRANSMITTER AND RECEIVER

#### 步驟2：開啓遙控器與接收器電源



Power ON  
電源開啟

Connect the power 接上電源

ESC → BATT

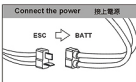

### STEP3 :

#### 步驟3 :

PC interface will display connection status.

電腦介面顯示連接狀況，連接成功會顯示已連線。



**Reset Bluetooth PW**  
設定藍牙密碼

When using smartphone app to make configuration changes, a Bluetooth password must be set for pairing with the smartphone. The factory default password is "0000". We strongly recommend you to change your password to avoid interference with others while Bluetooth transmission. 使用手機軟體介面(app)調整時，須設定藍牙連接密碼。原機手機連接時使用，預設密碼為"0000"。強烈建議使用者先更改密碼後再使用，以免對其他藍牙裝置造成干擾。

**Connected**  
連接狀態

Note: if connection failed, please check proper connectivity to Gpro, and that Gpro is powered up.

註：如某顯示未連線，請檢查Gpro連線是否正確，Gpro是否有電源輸入。

## 4.HELICOPTER HARDWARE CONNECTION 直升機硬體設定

### STEP1 :

#### 步驟1 :

a. Select "Setup Menu" to enter helicopter hardware configuration

a. 點選"直升機設定"進入機體的硬體設定



English

Please select language.  
選擇您所使用的語言

Setup Menu

Setup menu  
直升機設定

b. Select "Create New Settings" to wipe our previous settings, and perform the setting from scratch.

1. New helicopters that have not been setup before, please select "Create New Settings" and perform the complete setup procedure.
2. After initial setting of the Gpro, user can select "Edit Current Settings" to make adjustment changes.

b. 點選"建立全新設定"，選擇此項目將Gpro清除重置所有設定，進行新的直升機設定。

1. 新的直升機未經過設定前，務必選擇"建立全新設定"按順序從頭完整的設定一遍。
2. Gpro有完整設定完畢後，玩家可以選擇"修改原有設定"，調整Gpro設定。



There are 7 settings for helicopter configuration. Press "Next" after completing each and every of the 7 settings.

直升機設定共有7頁設定，每完成一頁設定請按"Next"換換設定，每項設定須逐一填寫完成。

## STEP2 : RC TRANSMITTER AND RECEIVER

### 步驟2：遙控器與接收器

a. First please select the receiver type.

**Note:** Transmitter must be set to H-1 (1-Servo-Normal) swashplate type. Please refer to page 24 for binding instruction if satellite receivers are used.

a. 請先選擇所使用接收器類型。

**注意：**遙控器務必設定為 H-1 (1-Servo-Normal) 傳統十字盤模式。如果您是使用衛星天線，請參考 P24 頁說明進行對頻。



**Note:** Entering Gpro helicopter setting, Gpro will depend on the configuration requirements, lock or unlock the helicopter movements. Each icon in the bottom right of the computer interface, represents each helicopter movement, if the icon is illuminated display, it means that you can set to open operation.

**註：**進入 Gpro 直升機設定，Gpro 會依不同設定需求，鎖定或解除直升機動作。電腦介面右下方各動作圖示，即表示直升機各動作。如果該動作圖示為亮燈顯示，即表示該設定真實此動作可以開啟運作。

b. Movements on the transmitter such as aileron, elevator, collective pitch, etc, must match synchronously with the display on PC interface. Using the diagram below as example, if moving aileron stick does not result in any movement of aileron channel inside PC interface, change the channel number on the upper left corner of aileron so that channel matches between transmitter and PC interface.

b. 遙控器之各動作，如副翼、升降、集體螺距等等，必須與電腦界面上的精選顯示一致。以下圖為例，若推動副翼桿時，如果電腦介面上副翼精選沒有反應，此時，可以更改副翼桿左上角的精選號碼，來讓遙控器與電腦介面的精選正確對應。



**Do not allow repetitive numbers when adjusting channel number, otherwise Gpro will not function properly.**

調整頻道號碼時，不得有重複號碼同時顯示，否則會造成 Gpro 運作錯誤。

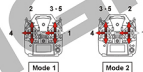

Move the aileron stick, PC interface should display corresponding control movements. Perform this check on all channels.

推動副翼桿時，電腦介面上副翼精選必須有正確輸出反應，同理檢查其他頻道。

**Note:** When using Gpro, every channel's neutral, direction, max/min end point must be set correctly. Throttle and pitch range must be set to straight diagonal line, and subtrim is set to 0 degrees. Using transmitter stick, channel direction, subtrim, and servo end point functions (EPA / Travel Adj), perform each channel's setting and adjustments.

**註：**使用 Gpro，遙控器各頻道中立點、方向與最大最小行程，必須確保設置正確。注意：設定此項目時，螺絲螺帽門與螺絲曲線為預設斜直線，並檢查遙控器預設是否為 0 度。利用遙控器桿、精選正反方向內置與伺服螺絲行程 (EPA / Travel Adj) 功能，進行各頻道的設定與校正。

c. Center the transmitter stick. At this point the aileron and elevator neutral point must be 0. If it's not 0, adjust using transmitter's subtrim function until 0 is achieved.

c. 將搖桿置中，此時副翼、升降舵中立點必須為 0。如果中立點不為 0 時，請利用遙控器內置調功能將中立點調整為 0。

Center transmitter sticks.  
遙控器桿置中





d. Confirm the direction of each channel. If interface displays opposite direction, reverse using the channel reverse function on transmitter so that movement of sticks corresponds to correct direction on interface. In addition, use EPA/Travel Adj function on transmitter to adjust the end points so that max/min travel corresponds to 100% and -100% on the interface.

d. 確認各頻道方向，如果介面顯示方向與操作方向相反，請調整遙控器內該頻道正方向，讓電腦介面與遙控器一致，並使用EPA、Travel ADJ功能將調整：升降與集體襟翼的極大、最小行程對應介面上輸出100%與-100%。

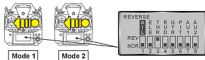
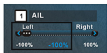

Also confirm all movement directions are correct. Incorrect movements can be reversed through transmitter's reverse function.

同時也要確認各動作輸出方向是否正確。如果不正確時，請由遙控器頻道正轉設定調整正確方向。



Using the transmitter's EPA/Travel ADJ function, adjust the maximum/minimum travel on the PC interface to 100% and -100% respectively.

使用遙控器EPA、Travel ADJ功能，將電腦介面上最大、最小行程調整至100%與-100%。



Note: Must adjust the max and min travel of aileron/elevator/pitch to correspond with 100% and -100% of transmitter stick.

注意：必須將調整、升降、集合襟翼的極大及最小行程對應遙控器的100%與-100%。

### STEP3 : SENSOR MOUNTING & BLADE DIRECTION

步驟3：陀螺儀安裝與主旋翼旋轉方向

a. Gpro can be mounted 4 ways as shown in diagram. Arrow can point forward or backward. User need to select one of the mounting choices based on helicopter design. The actual mounting of the gyroscope must match to the position selected here.

b. In order for Gpro to achieve optimal performance, the main rotor rotation direction needs to be selected. All Align helicopters are clockwise rotation.

a. Gpro 具備4種安裝方式，如電腦介面顯示，箭頭指示標識明的或朝後，玩家需要依直昇機結構設計，選擇其一方式安裝，所選安裝方式必須與實際安裝相同，否則會造成Gpro修正方向錯誤。

b. 為了讓Gpro有更優異性能必須設置主旋翼旋轉方向，所有亞拓直昇機都是順時針旋轉方向。

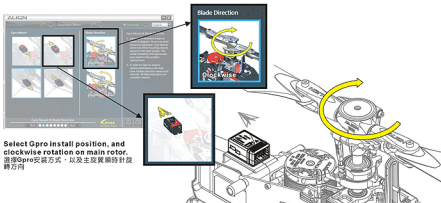

Select Gpro install position, and clockwise rotation on main rotor. 選擇Gpro安裝方式，以及主旋翼順時針旋轉方向

## STEP4 : PITCH DIRECTION & SWASH TYPE

### 步驟4：螺距方向與十字盤類型

- a. Gpro needs to know which direction swashplate moves during positive pitch movement. All Align helicopters are upward moving swashplate during positive pitch.  
 b. Select the swashplate type based on the helicopter. Then confirm the direction of each movement is correct. If reversed, correct by selecting the corresponding reverse option on this interface.

a. Gpro 需要知道直昇機正螺距時，十字盤的移動方向，所有亞拓直昇機都為正螺距十字盤向上的方式。

b. 請依直昇機十字盤類型，選擇正確的十字盤，接著要確認直昇機十字盤運作方向，如果有錯誤，請調整介面上的伺服器正反向，使十字盤運作正確。



For this step, do not reverse the servo using transmitter's reverse function.

此步驟不可調整遙控器的頻道正反向功能。



Select positive pitch swashplate up mode, and HR-3 T-REX 550L Dominator swashplate type.

選擇正螺距十字盤向上方式，以及HR-3 T-REX 550L Dominator的十字盤類型。

Swashplate must move up. If there are any incorrect servo movements, adjust the servo direction per diagram on left until correct movement is achieved.

十字盤必須向上，如果有任何錯誤的動作錯誤，請調整左邊的伺服器正反向，使十字盤動作正確。

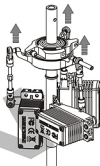

## STEP5 : SWASHPLATE ADJUSTMENT

### 步驟5：十字盤調整

- a. Adjust the neutral point of each servo and swashplate level. Using the subtrim function on the interface here, adjust the neutral point of each servo so that servo arm is level at 0 degrees. Follow by the adjustment of push rod length or cyclic pitch subtrims here to achieve horizontal level of swashplate.

a. 調整各伺服器中立點與十字盤的水平，利用介面上的伺服器微調功能，逐一調整各伺服器中立點，讓伺服器離開水平0度，並配合拉桿長度的調整或遙桿微調，使十字盤呈水平。

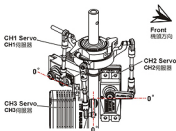

- b. Swashplate level can also be adjusted here through cyclic pitch trim function.

b. 這邊也可以利用遙桿微調功能，調整十字盤水平。

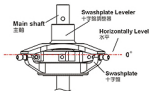

Swash leveler can be used during swashplate leveling adjustments.

調整十字盤水平可以用十字盤調整器，進行調整，來確保十字盤水平狀態。

c. After swashplate is leveled, adjust the collective pitch using the collective pitch subtrim and a pitch gauge, so that pitch is 0 degrees at collective pitch neutral point.

c. 十字盤水平後，利用集體螺距微調且搭配數位螺距規使用，將集體螺距中間點調為0度。

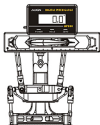

## STEP 6 : COLLECTIVE PITCH AND CYCLIC PITCH

### 步驟6：集體螺距&循環螺距

a-1. Push throttle stick to maximum position. Using the positive collective pitch parameter and a pitch gauge, adjust the maximum pitch angle. At this time, the cyclic pitch subtrims below can be used to achieve swashplate level during maximum pitch.

a-1. 將油門推桿推至最大，利用正向集體螺距參數配合數位螺距規使用，來調整所需的最大螺距角度。此時也可以使用下方的循環螺距微調，來調整最大螺距時的十字盤水平。



Push throttle to the highest.  
油門推至最高

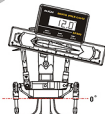

a-2. Push throttle stick to minimum position. Using the positive collective pitch parameter and a pitch gauge, adjust the minimum pitch angle. At this time, the cyclic pitch subtrims below can be used to achieve swashplate level during minimum pitch.

a-2. 將油門推桿推至最小，利用正向集體螺距參數配合數位螺距規使用，來調整所需的最小螺距角度。此時也可以使用下方的循環螺距微調，來調整最小螺距時的十字盤水平。



Push throttle to the lowest.  
油門推至最低

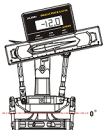

Please unplug motor wires or activate the throttle HOLD when performing Gpro configuration.  
進行Gpro設定時，請拔除馬達線或切到油門HOLD模式，設定完畢後再重新開啟Gpro電源。

b. Gpro's cyclic pitch must be set to 8 degrees. Push the "Set to 8 degrees pitch" button, swashplate will tilt to one side. Use a pitch gauge and adjust the cyclic pitch parameter until pitch achieve 8 degrees.

b. Gpro 循環螺距必須設定為“8度”。請先按“設定在8度螺距”，此時十字鐘會傾斜一邊，使用數位螺距規調整“循環螺距”數值，讓角度達到8度。



Note: When adjusting cyclic pitch, swashplate will be locked at "8 degrees cyclic pitch" or "0 degrees pitch" when selected. Press "Release" after completion of adjustments.

註：調整循環螺距時，當您按下“設定在8度螺距”或“0度螺距”，十字鐘會鎖在該設定，調整完畢後請按“解除鎖定”後，才會解除螺距鎖定。

## STEP7 : RUDDER SETTING

### 步驟7：尾舵設定

a. First select the type of rudder servo.

b. Confirm rudder servo direction. Reverse on the interface if needed.

a. 先選擇所使用尾舵伺服器種類。

b. 確認尾舵方向，如果不正確，可調整介面上的尾舵方向。

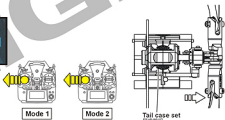

Pushing rudder stick to left will cause tail pitch slider to slide right as show above. Reverse rudder direction if incorrect.

尾舵打左舵，尾滑套會向右移動，如上圖所示。如果不正確，請更改尾舵方向。

c. Rudder center can be adjusted through Neutral Position setting. Please follow the diagram below, adjust so that servo horn is 90° to servo, and rudder pitch slider is in the middle position.

c. 您可以利用尾舵中立點設定來調整中立點。調整請依下面所示，伺服器的片須與伺服器呈90°，且尾滑套須在置中位置。

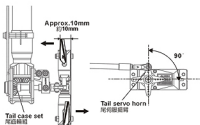
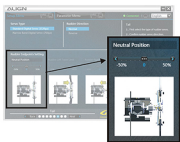

d. Push rudder stick on transmitter all the way left, and adjust the parameter on interface so the rudder is at maximum left without binding.

d. 將遙控器尾舵搖桿左推至最大，調整介面上的數值，讓左舵至最大不干涉。

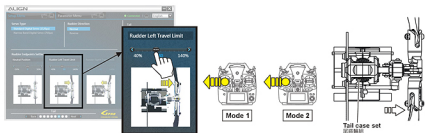

e. Push rudder stick on transmitter all the way right, and adjust the parameter on interface so the rudder is at maximum right without binding.

e. 將遙控器尾舵搖桿右推至最大，調整介面上的數值，讓右舵至最大不干涉。

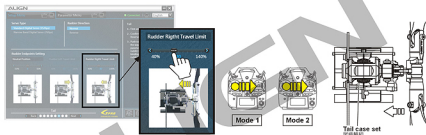

Note: please set the rudder gain in heading lock mode, actual gain value differs amongst servos and helicopters. The goal is to find the maximum gain without tail hunting. This can only be done through actual flight tests.

註：請將尾舵增益設定為鎖定模式，增益值的大小會隨著伺服與直昇機的不同而有所差異，一般而言，在不產生盪尾現象（直昇機尾部出現左右搖擺的情況）的前提下將數值調高為好，所以只能透過實際飛行的狀況來進行調整。

## STEP8 : GLOW(NITRO) THROTTLE GOVERNOR

### 步驟8：引擎直昇機定速器



If your helicopter is an electric helicopter. This section can be skipped.

如果您使用的是電動直昇機，請略過此項設定。

Glow(nitro) helicopters can activate governor function here. The RPM sensor must be installed correctly on helicopter.

燃油直昇機可以開啟油機定速功能使用，直昇機上務必正確安裝定速感應器。

a. Turn ON governor function, and enter the correct gear ratio.

b. Push throttle stick to minimum position, press SET to record minimum value. Then push throttle stick to maximum and press SET to record maximum value.

a. 將定速功能開啟，並輸入正確的齒輪比。

b. 將油門搖桿拉至最低，按下“設定”記錄最小值，接著油門搖桿推至最高，按下“設定”記錄最大值。



This speed governor function is for nitro power only. Do not activate this function if your helicopter is electric powered. Otherwise it may cause unintentional motor spin-ups, resulting in dangerous situations.

此定速模式為引擎直昇機專用功能，如果您使用的是電動直昇機，請勿開啟此功能，否則會造成馬達旋轉，若發生不可預期的危險。

## STEP 9: COMPLETE HELICOPTER SETUP.

步驟9：完成直昇機設定

After completing helicopter setup, please proceed to flight parameter setup.

完成直昇機設定後，請繼續進行飛行參數設定。



Load Setup File  
讀取直昇機設定檔案



Save Setup File  
儲存直昇機設定檔案

Gpro provides saving function for parameters (both helicopter setting and flight parameters). After completing setup, you can save the configuration parameters into PC for future use.

Gpro提供設定參數直昇機設定、飛行參數儲存功能。設定完畢後，您可以將設定參數儲存至電腦，方便日後設定調用。

## 5.PARAMETER MENU 飛行參數設定

Flight parameter consists of adjustments to improve helicopter flight characteristics and styles. You can fine tune these parameters to suit your preference. Gpro has flight enhancement specific to helicopter sizes. Please select the correct helicopter class on this settings page.

飛行參數是提升直昇機飛行特性與風格上的調整，您可依照個人操作手感與喜好，調整符合您需求的飛行手感。Gpro針對大小直昇機進行飛行優化，所以在此設定頁面，您必須選擇正確直昇機類別的設定。



Load Parameter File  
讀取飛行參數檔案



Save the file  
儲存飛行參數檔案

Gpro provides saving function for parameters (both helicopter setting and flight parameters). After completing setup, you can save the configuration parameters into PC for future use.

Gpro提供設定參數直昇機設定、飛行參數儲存功能。設定完畢後，您可以將設定參數儲存至電腦，方便日後設定調用。

**Beginner Settings:** if you are a beginner or unfamiliar with radio control, please select "Beginner Settings" so that Gpro can provide more stable and more suitable control feel.

初學者建議參數：如果您剛入門或操控技術不純熟，建議點選「初學者建議參數」，此類設置可以讓Gpro有更穩定、更適合您的操控手感。



When Gpro is connected to the PC or smartphone for configuration setup, Gpro will disable electronic speed control. After completing setup, remember to power Gpro back on.

當Gpro連上電腦或手機進行調整時，請拔掉主馬達動力電源，待完成調整設定後，務必重新開啟接收器電源。

## Gpro SPECIFICATIONS Gpro產品規格

1. Operating voltage range: DC 3.5V-8.4V
2. Operating current consumption: <100mA @4.8V
3. X and Y axis Operating Angle Range: -300~+300 degree
4. Z axis Operating Angle Range: -600~+600 degree
5. Sensor resolution: 12bit
6. Supports 90/120/135/140 CCPM wash plates
7. Spektrum and JR Satellite antennas support  
(Replaces original factory receiver)
8. Futaba S.BUS/JR X.BUS system support
9. Rudder support 760  $\mu$  narrow band servos.
10. Supports multi-blade rotor heads.
11. Engine speed governor range: 10500-21000 RPM
12. Operating Temperature: -20~65degree
13. Operating Humidity: 0%-95%
14. Size/Weight: 36.5x25.2x15.6 mm Size/11.5g
15. RoHS certification stamp

1. 適用電壓: DC 3.5-8.4V
2. 消耗電流: <100mA @ 4.8V
3. 俯仰側滾及俯滾角速度:  $\pm 300$ 度/sec
4. 偏航偏航角速度:  $\pm 600$ 度/sec
5. 感測器解析度: 12位元(12 BIT)
6. 支援傳統90度與120、135、140度CCPM十字盤
7. 支援Spektrum與JR衛星天線
8. 支援Futaba S.BUS/JR X.BUS系統接收機
9. 尾舵支援760  $\mu$ 窄頻伺服器
10. 支援多葉槳頭
11. 引擎速度調節範圍: 10500-21000RPM
12. 操作溫度: -20℃~65℃
13. 操作濕度: 0%-95%
14. 尺寸/重量: 36.5x25.2x15.6mm/11.5g
15. 符合RoHS限用標準

This new Brushless motor developed by the ALIGN POWER R&D TEAM, is packed with the latest, cutting edge technology available today. It features exceptional levels of high-torque power. The 730MX utilizes an 8-pole outrunner stator-rotor and unrivaled Ndfeb extra strong magnets that traditional magnets cannot compare to. Also included is a high temperature, wear-resisting, low friction, double ZZ high efficiency bearing. The 730MX will be the most revolutionary motor operating on low current amperage, and delivering high torque to RC models.

由亞拓動力團隊獨家研發出新款的無刷馬達，具有超高扭力特色，採用12槽矽鋼片、8極外轉子以及傳統鐵磁辦法比較的強磁釹鐵硼磁鐵，搭配高溫耐用的雙ZZ超高效能精密軸承設計，電流低、扭力強，將是下一代激進革命中的最具代表性的一顆星。

## RCM-BL730MX MOTOR RCM-BL730MX 無刷馬達

## SPECIFICATION 尺寸規格

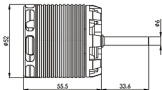

(Unit:mm)

KV	KV值	850KV(RPM/V)	Input voltage	輸入電壓	6S
Stator Arms	矽鋼片槽數	12	Magnet Poles	磁鐵極數	8
Max continuous current	最大持續電流	115A	Max instantaneous current	最大瞬間電流	195A(5sec)
Max continuous power	最大持續功率	2550W	Max instantaneous power	最大瞬間功率	4330W(5sec)
Dimension	尺寸	Shaft $\phi$ 6x52x39.1mm	Weight	重量	Approx. 380g

## ILLUSTRATION 接線示意圖



The motor rotates in different direction with different brand ESCs. If the wrong rotating direction happens, please switch any two cables to make the motor rotates in right direction.

由於各品牌電子變速器的馬達旋轉方向不相同，若發生轉向錯誤時，請將馬達與電子變速器的接線任兩條對調即可。

## PRODUCT FEATURES 產品特點

- Brushless motor operation up to 90 amps with 6S (25.2V) max input.
  - Up to 20 amp BEC output. Continuous rating of 9 amps.
  - User selectable BEC voltage, 6 or 8 volts.
  - Advanced governor modes and autorotate bailout capabilities may be accessed using Castle Link USB adapter (coupon included in this package) and free Windows software. ([www.castlecreations.com](http://www.castlecreations.com))
- 支援6S (25.2V) 無刷馬達運作，最大輸入為90安培。
  - BEC 最大輸出20安培，持續9安培。
  - 使用者可調整選擇BEC輸出電壓，6伏或8伏。
  - 透過Castle Link USB選配器，與免費的Windows軟件 ([www.castlecreations.com](http://www.castlecreations.com))，可以使用馬達定速模式與熄火故障緊急回復功能。

## WIRING ILLUSTRATION 接線示意圖

Castle Talon 90 Brushless ESC  
Castle Talon 90 無刷變速器

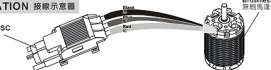

## SPECIFICATION 產品規格

- |  |   |
|--|---|
| <ol style="list-style-type: none"> <li>Operating Voltage : 3S Min 6S Max (12V-25.2V).</li> <li>Continuous Current : 90 amps.</li> <li>Peak Current : 140 amps for 5 seconds. With proper cooling and ESC exterior temp at or below 70C.</li> <li>BEC output : 20 amp peak, 9 amps continuous. Always check servo draw prior to flight.</li> <li>Dimensions : 80(L) x 43 (W) x 18(H) mm.</li> <li>Weight : 84.5g with 150mm power wires.</li> <li>Max RPM : 320,000 divided by motor pole count.</li> </ol> | <ol style="list-style-type: none"> <li>輸入工作電壓：3S -6S (12V-25.2V)。</li> <li>輸出持續電流：90 amps。</li> <li>最高耐電流：140安培持續5秒。需具有良好的散熱和ESC外部溫度等於或低於70°C。</li> <li>BEC輸出：瞬間20安培，持續9安培。飛行前請務必檢查電機驅動件。</li> <li>尺寸：80(L) x 43 (W) x 18(H) mm。</li> <li>重量：84.5克包含150mm電源線。</li> <li>最高RPM：320,000除以馬達的極數。</li> </ol> |
|--|---|

## INITIAL SETTINGS AND OPERATION 初始設置和操作

- |   |   |
|---|---|
| <ol style="list-style-type: none"> <li>Throttle Type : Fixed-Endpoints</li> <li>Throttle Response : 5 medium</li> <li>Initial Spool-Up Rate : 5 medium</li> <li>Head Speed Change Rate : 8 high</li> <li>Low Voltage Cutoff Type : Soft Cutoff</li> <li>PWM Rate : 12 kHz</li> <li>Auto-Lipo Volts/Cell : 3.2 Volts/Cell</li> <li>Cutoff Voltage : Auto-LIPO</li> <li>BEC Voltage : 6.0V</li> </ol> | <ol style="list-style-type: none"> <li>油門形式：固定行程</li> <li>油門反應：5（中）</li> <li>緩啟動速率：5（中）</li> <li>主旋翼轉速變換速率：8（高）</li> <li>低電壓截止類型：緩斷電</li> <li>PWM：12 kHz</li> <li>Auto-Lipo Volts/Cell：3.2 Volts/Cell</li> <li>截止電壓：Auto-LIPO</li> <li>BEC 輸出電壓：6.0V</li> </ol> |
|---|---|

This controller is configured with settings chosen by Align Corporation for this heli and motor combination. No controller programming is required to operate your heli.

The ESC is configured to run your heli motor using a traditional helicopter throttle curve in your radio. Refer to your radio transmitter's instructions for directions.

The Talon 90 ESC requires a LOW throttle setting after power up to arm. Futaba users may have to reverse throttle channel operation for proper operation.

此調速器的配置為針對亞特蘭斯直升機與馬達的設定。無須另外設定。

Talon 90 ESC 有一項於開電之後須為最低油門的保護措施。Futaba 的使用者需將油門通道設置為反向後才可以正常運作。

## CHANGING USER SELECTABLE SETTINGS BY COMPUTER 用戶可透過電腦更改選擇的設置

This controller supports a number of helicopter throttle types including Castle's direct entry governor mode. Users may access these settings using a Castle Link USB adapter (A coupon for an adapter is included in this package) and Castle's freely downloadable Castle Link software. ([www.castlecreations.com](http://www.castlecreations.com)).

Most pilots prefer using the direct entry governor mode as it is extremely easy to set up and it offers them optimal performance.

Please visit the Castle website for instructions on how to set up the advanced programmable features of your Castle Link. ([www.castlecreations.com](http://www.castlecreations.com)) 變更更設定。

此調速器支援多種的直升機油門類型，包括 Castle 提供的定速模式。使用者也可以透過 Castle Link USB 适配器與提供免費下載的 Castle Link 軟體

許多飛行員習慣使用定速模式，因為它容易設定，並且為他們提供了最佳的性能。

請參訪 Castle 網站的說明，以了解如何進一步設置 Castle Talon 的功能。

## CHANGING USER SELECTABLE SETTINGS BY TRANSMITTER 用戶可由遙控器更改選擇的設置

Once ESC is connected to a motor and radio receiver, follow these steps to enter programming mode and change selected values.

- Power ESC with TX throttle stick (stick) in the top position (full throttle). LED will repeat a quick single flash.
- Move stick to the middle. ESC will emit a short tone, and LED repeats a quick double flash. Repeat high / medium through to a triple flash.
- ESC will emit four short tones, and the LED repeats a long single flash.
- To step through settings and values by answering "Yes"(full throttle) or "NO"(low throttle). The setting and value are "Flashed" out by the LED. Example: setting #3 value #2. = 3 beeps/flashes, then 2 beeps/flashes. Answering "NO" moves to the next value. A "YES" answer is signaled by rapid LED flashes and a constant beep.
- Move the stick to the middle position to move to next setting. Repeat steps 4 and 5 as needed.
- Once the desired settings are entered, and removed, then reconnect power. Arm speed control as normal.

一旦ESC連接到馬達和接收機，請按照下列步驟操作。進入設定模式。更改您所選的數值。

- 將遙控油門桿位置拉至高位置（全開）並開啟 Castle ESC 電源。LED 將重複的快速閃爍一次。
- 將油門桿移至中間。Castle ESC 會發出短促的提示音，LED 將重複的快速閃爍二次。再重複上述步驟 → 高油門 → 中海門進入快速閃爍三次。
- 步驟3. Talon ESC 會發出四聲短音，LED 會重複閃爍一次。
- 步驟4. 藉由拉油門“是”（全油門）或“否”（低油門）的步驟來改變設置數值和數值。設置選項與數值由LED的“閃爍”表示。例如：設置選項#3數值#2會以3次閃爍/閃爍。接著2次快閃/閃爍來表示。回答“否”來移動到下一個數值。回答“是”選擇該數值後LED將會快速的閃爍，並持續的發出連續音來表示。
- 步驟5. 將油門桿移動到中間位置來移動到下一個設置選項。根據需要重複步驟4和5。
- 步驟6. 一旦輸入與接收機所需的設置，然後重新連接電源。調整器的開機速度就會回到正常。

Setting 設置選項	Battery cell cutoff voltage 電池低電壓保護	Brake Type 煞車模式	Low Voltage Cutoff Type 低電壓保護新電模式	PWM Switching Rate PWM 頻率
Value 1 數值1	3.0V	Only in fixed wing mode 僅限於固定翼模式	Hard 急斷電	8kHz
Value 2 數值2	3.1V	Only in fixed wing mode 僅限於固定翼模式	Soft (factory setting) 緩斷電 (初始設定)	12kHz (factory Setting) 12kHz (初始設定)
Value 3 數值3	3.2V (Factory setting) 3.2V (初始設定)	Only in fixed wing mode 僅限於固定翼模式	RPM decrease RPM 減少	16kHz
Value 4 數值4	3.3V	Only in fixed wing mode 僅限於固定翼模式	Pulsing throttle 油門脈衝性輸出	—
Value 5 數值5	3.4V	Only in fixed wing mode 僅限於固定翼模式	—	—
Value 6 數值6	DISABLED 禁用	Brake disabled (factory setting) 無煞車 (初始設定)	—	—

- Always refer to battery vendor's instructions for voltage setting.
- Refer to motor manufacturer's instructions for frequency setting.

- 請務必參閱電池供應商所標示的電壓設定。
- 請參閱馬達製造商的標示頻率設定。



## STEP1 步驟1

Turn on Transmitter, and then receiver power.  
先開啟遙控器電源，再開啟接收器電源。

## STEP2 步驟2

Do not move the helicopter of control sticks so the gyro sensor can initialize properly.  
請勿移動直昇機與搖動搖桿，以利陀螺儀感應器進入初始化程序。

## STEP3 步驟3

As shown, swashplate will jump horizontally once indicating successful initialization. If the swashplate is tilted while jumping, this is an indication of improper setup, requiring performing the flybarless setup again (Please refer to flybarless system setup). Until the helicopter is properly initialized, helicopter pitch will not be moveable. If the system cannot initialize and the STATUS LED is flashing red, please check to ensure helicopter is stationary, or if there are any loose connections. After proper initialization, green STATUS LED indicates rudder tail locking mode, while red LED indicate non-tail locking mode.

如圖示，初始化完成後，十字盤會保持水平上下小幅度跳動一次，表示完成開機程序；如十字盤為搖斜跳動一次，則表示設定錯誤，並進入重新調整系統設定。(參考Gpro飛手副翼系統設定)完成開機後直昇機將在機架固定架動作。如果一直無法完成開機程序STATUS紅燈閃爍，請檢查飛機的直昇機是否停止或訊號線未接妥，確認後重新開機。正常開機後，STATUS亮綠燈表示尾舵為鎖定模式，亮紅燈為非鎖定模式。

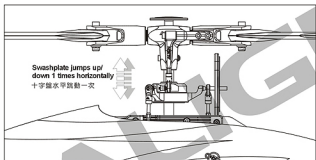

○ Swashplate jumps up and down 1 times horizontally represents successful initialization.  
十字盤水平跳動一次代表正常開機



✗ Swashplate jumps up and down 1 times tilted represents setup error.  
十字盤傾斜跳動一次代表設定錯誤



Green = rudder in heading lock mode  
Red = rudder in normal mode

綠燈為尾舵鎖定模式  
紅燈為尾舵非鎖定模式



## STEP4 步驟4

Tilt the helicopter forward, gyro should compensate by tilting swashplate back. If incorrect, go back to helicopter setup and check for proper setting in gyro and main rotor direction.

將直昇機往前傾，陀螺儀應將十字盤向後修正。如果不正確，重新進入“直昇機設定的陀螺儀&主旋翼方向”確認陀螺儀安裝方向是否正確。

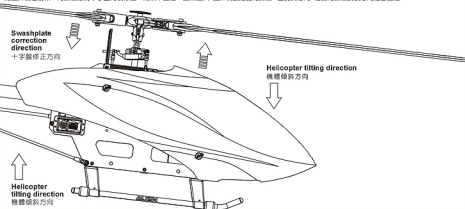

### STEP5 步驟5

Tilt the helicopter right, gyro should compensate by tilting swashplate left. If incorrect, go back to helicopter setup and check for proper setting in gyro and main rotor direction.

將直昇機往右傾，陀螺儀應將十字盤向左修正，如美不正確，重新進入「直昇機設定」的陀螺儀&主旋翼方向，確認陀螺儀安裝方向是否正確。

### STEP6 步驟6

Check the center of gravity (CG) and adjust component placement until CG point is right on the main shaft of the helicopter.

檢視直昇機重心是否適當請先調整直昇機重心位置至主軸中心線下方位置。

### STEP7 步驟7

With all above steps checked, restart the system and begin flight test.

確認所有功能正常，重新開機，完成開機程序後進入飛行測試。

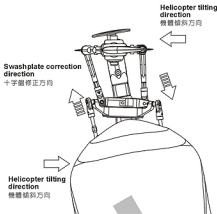

## HELICOPTER CG CHECK PROCEDURE 直昇機機體重心檢視方式

After installed the battery, hold the helicopter as shown. Once the helicopter stops rotating, the helicopter's CG can be seen at where the head is pointing relative to the main shaft.

電池固定後，將直昇機如圖示舉起，等待直昇機停止轉動後檢視機頭方向，正確重心應落在機身（主軸附近）位置。

Adjust the frame's CG within +/- 60 degrees from level.

以水平線上下夾角 60° 內為適當的範圍來調整機體的重心。

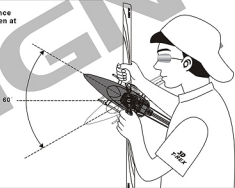

## 19. FLIGHT ADJUSTMENT AND SETTING 飛行動作調整與設定

**ALIGN**

### PLEASE PRACTICE SIMULATION FLIGHT BEFORE REAL FLYING 飛行前請先熟練電腦模擬飛行











A safe and effective practice method is to use the transmitter flying on the computer through simulator software sold on the market. Do a simulation flight until you familiarize your fingers with the movements of the rudders, and keep practicing until the fingers move naturally.

1. Place the helicopter in a clear open field ( Make sure the power OFF ) and the tail of helicopter point to yourself.
2. Practice to operate the throttle stick (as below illustration) and repeat practicing "Throttle high/low", "Aileron left/right", "Rudder left/right", and "Elevator up/down".
3. The simulation flight practice is very important, please keep practicing until the fingers move naturally when you hear operation orders being call out.

在還沒瞭解直昇機各動作的操控方式前，嚴禁實際飛行，請先進行電腦模擬飛行的練習，一種最有效、最安全的練習方式，就是透過市面販售的模擬軟體，以遙控器在電腦上模擬飛行，熟悉各種方向的操縱，並不斷的重複，直到手指可熟練的控制各個動作及方向。

1. 將直昇機放在空曠的地方(確認電源為關閉)，並將直昇機的機尾對準自己。
2. 練習操作遙控器的各桿桿(各動作的操作方式如下圖)，並反覆練習油门/螺、副翼左/右、升降的俯/後及方向舵左/右操作方式。
3. 模擬飛行的練習相當重要，請重複練習直到不講思索，手指能自然隨著叫出的指令移動控制。

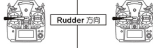

Mode 1	Mode 2	Illustration 圖示
 <p>Aileron 副翼</p>		 <p>Move left 左移 Move right 右移 Rotate left 左轉 Rotate right 右轉</p>
 <p>Elevator 升降/前進</p>		 <p>Fly forward 前進 Fly backward 後退 Forward rotate 前轉 backward rotate 後轉</p>
 <p>Throttle 油門</p>		 <p>Ascent 上升 Descent 下降</p>
 <p>Rudder 方向</p>		 <p>Turn right 右旋 Turn left 左旋</p>

## FLIGHT ADJUSTMENT AND NOTICE 飛行調整與注意



- ⊙ Check if the screws are firmly tightened.
- ⊙ Check if the transmitter and receivers are fully charged.
- ⊙ 再次確認—螺絲是否鎖緊?
- ⊙ 發射器和接收器電池是否足電。



If there are other radio control aircraft at the field, make sure to check their frequencies and tell them what frequency you are using. Frequency interference can cause your model, or other models to crash and increase the risk of danger. 假使飛行場有其他遙控飛機，請確認他們的頻率，並告知他們您正在使用的頻率。相同的頻率會造成干擾導致失控和大大地增加風險。

- When arriving at the flying field.
- 當抵達飛行場



## STARTING AND STOPPING THE MOTOR 啟動和停止馬達



First check to make sure no one else is operating on the same frequency. Then place the throttle stick at lowest position and turn on the transmitter. 首先確認附近沒有其他相同頻率的使用者，然後打開發射器將油門搖桿推到最低。



Check if the throttle stick is set at the lowest position. 確認油門搖桿是在最低的位置。



- Check the movement.
- 動作確認



**ON! Step1**  
First turn on the transmitter.  
先開啟發射器



**ON! Step2**  
Connect to the helicopter power  
插上直昇機電源

- ⊙ Are the rudders moving according to the controls?
- ⊙ Follow the transmitter's instruction manual to do a range test.
- ⊙ 方向舵是否隨著控制方向移動?
- ⊙ 根據發射器說明書進行距離測試。



**OFF! Step3**  
Reverse the above orders to turn off.  
關閉電源時請依上述操作動作反執行。

This procedure is best performed on soft surfaces such as grass. The use of rubber skid stopper is recommended on hard surface to prevent vibration feedback from the ground to Gpro, resulting in over-corrections.

將直升機置於柔軟地面上，建議硬地起飛腳架裝上避震墊圈。避免升空在腳架與硬地的地面震動太大反應至機身上的Gpro，影響無平衡系統。直升機過震修正。

Rubber skid stoppers installed  
裝上避震墊圈



If swashplate should tilt prior to lift off, do not try to manually trim the swashplate level. This is due to vibration feedback to the Gpro, and will disappear once helicopter lifts off the ground. If manual trim is applied, helicopter will tilt immediately after liftoff.

直升機離地前，十字盤可能會因Gpro受震動的反應，使十字盤有傾斜的情形，此時請勿重新將十字盤修正為水平狀態，此現象只要離地升空時立即解除，即可平衡升空；若回震將十字盤修正為水平時，反而會造成感應器過修正，一般地都僅在修正方向的軌跡。

## MAIN ROTOR ADJUSTMENTS 主旋翼雙槳平衡調整

1. Before adjusting, apply a red piece of tape on one blade, or paint a red stripe with a marker or paint to identify on blade.
2. Raise the throttle stick slowly and stop just before the helicopter lifts-off ground. Look at the spinning blades from the side of the helicopter.
3. Look at the path of the rotor carefully. If the two blades rotate in the same path, it does not need to adjustment. If one blade is higher or lower than the other blade, adjust the tracking immediately.

1. 調整前先在其中一支主旋翼的槳面，貼上有顏色的貼紙或畫上顏色記號，方便雙槳調整辨識。
2. 慢慢的推起油门桿到高點並停止，在飛機離地前查看，從飛機側面觀察主旋翼轉動。
3. 仔細觀察旋翼軌跡如兩支旋翼移動都是相同軌跡，則不需要調整；可是如果一支旋翼軌高或較低產生“雙槳”的情形時，則必須立刻調整軌跡。

- a. When rotating, the blade with higher path means the pitch is too big. Please shorten DFC ball link for regular trim.  
b. When rotating, the blade with lower path means the pitch too small. Please lengthen DFC ball link for regular trim.

- a. 旋翼轉動時較高軌跡的主旋翼表示螺距(PITCH)過大，請縮短DFC連桿調整。  
b. 旋翼轉動時較低軌跡的主旋翼表示螺距(PITCH)過小，請調長DFC連桿調整。



Tracking adjustment is very dangerous, so please keep away from the helicopter at a distance of at least 10m.

調整軌跡非常危險，請於距離飛機最少10公尺的距離。

Incorrect tracking may cause vibrations. Please repeat adjusting the tracking to make sure the rotor is correctly aligned. After tracking adjustment, please check the pitch angle is approx. +5~6° when hovering.

不正確的旋翼軌跡會導致震動，請不斷重複調整軌跡，使旋翼軌跡精準正確。  
在調整軌跡後，確認一下Pitch角度在停空時應為大約+5~6°。

Color mark 有標示記號的主旋翼



## FLIGHT ADJUSTMENT AND NOTICE 飛行調整與注意

- ⊙ During the operation of the helicopter, please stand approximately 10M diagonally behind the helicopter.  
⊙ 飛行時，請站在直升機後方最少10公尺。



- ⊙ Make sure that no one or obstructions in the vicinity.
- ⊙ For flying safety, please carefully check if every movement and directions are correct when hovering.
- ⊙ 確認鄰近地區沒有人和障礙物。
- ⊙ 為了飛行安全，您必須先確認停懸時各項操作是否正確。



Do not attempt until you have some experiences with the operation of helicopter.  
嚴禁無熟練操控飛行經驗者操縱飛行。

## STEP 1 THROTTLE CONTROL PRACTICE 油门控制練習

- ① When the helicopter begins to lift-off the ground, slowly reduce the throttle to bring the helicopter back down. Keep practicing this action until you control the throttle smoothly.

② 當直昇機開始離地時，慢慢降低油门將飛機降下，持續練習飛機從地面上升和下降直到您覺得油门控制很順。

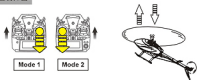

## STEP 2 AILERON AND ELEVATOR CONTROL PRACTICE 副翼和升降控制練習

1. Raise the throttle stick slowly.  
2. Move the helicopter in any direction back, forward, left and right, slowly move the aileron and elevator sticks in the opposite direction to fly back to its original position.

1. 慢慢升起油门搖桿。  
2. 使直昇機依指示：移動向後/向前/向左/向右，慢慢的反向移動副翼和升降搖桿並將直昇機調回到原來位置。



① If the nose of the helicopter moves, please lower the throttle stick and land the helicopter. Then move your position diagonally behind the helicopter 10M and continue practicing.

② If the helicopter flies too far away from you, please land the helicopter and move your position behind 10M and continue practicing.

③ 當直昇機機頭偏移時，請降低油门並且降落，然後移動自己的位置到直昇機的正後方10公尺再繼續練習。

④ 假如直昇機飛離你太遠，請先降落直昇機，並對直昇機後10公尺再繼續練習。

## STEP 3 RUDDER CONTROL PRACTICING 方向舵操作練習

1. Slowly raise the throttle stick.  
2. Move the nose of the helicopter to right or left, and then slowly move the rudder stick in the opposite direction to fly back to its original position.

1. 慢慢升起油门搖桿。  
2. 將直昇機機頭移動左或右，然後慢慢反向移動方向舵搖桿並將直昇機飛回原本位置。

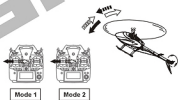

## STEP 4

After you are familiar with all actions from STEP1 to 3, draw a circle on the ground and practice within the circle to increase your accuracy.

當你覺得 STEP1-3 動作熟悉了，在地上畫圓並在這個圓的範圍內練習飛行，以增加你操控的準確度。

① You can draw a smaller circle when you get more familiar with the actions.

② 當您更加習慣或動作，您可以畫更小的圓。

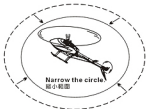

## STEP 5 DIRECTION CHANGE AND HOVERING PRACTICE 改變直昇機方向和練習停旋

After you are familiar with STEP1 to 4, stand at side of the helicopter and continue practicing STEP1 to 4. Then repeat the STEP1 to 4 by standing right in front of the helicopter.

當你覺得STEP1-4動作熟悉了，站在面對直昇機側邊並繼續練習STEP1-4。之後，站在直昇機機頭右邊重複步驟練習。



	Problem 狀況	Cause 原因	Solution 對策
Blade Tracking 雙槳平衡	Tracking is Off 置位	Pitch linkage rods are not even length PITCH連桿長度調整不平均	Adjust length of DFC ball link. 調整DFC連桿球連桿長度
Hover 停懸	Headspeed too low 主旋翼轉速偏低	Excessive pitch 主旋翼的PITCH偏高	Adjust DFC ball link to reduce pitch by 4 to 5 degrees. 調整DFC連桿球連桿(Pitch) +4-5度
		Hovering throttle curve is too low 停懸點油门曲線過低	Increase throttle curve at hovering point on transmitter (around 60%) 調高停懸點油门曲線(約60%)
	Headspeed too high 主旋翼轉速偏高	Not enough pitch 主旋翼的PITCH偏低	Adjust DFC ball link to increase pitch by 4 to 5 degrees. 調整DFC連桿球連桿(Pitch) +4-5度
		Hovering throttle curve is too high 停懸點油门曲線過高	Decrease throttle curve at hovering point on transmitter (around 60%) 調低停懸點油门曲線(約60%)
Rudder Response 尾舵反應	Drifting of tail occurs during hovering, or delay of rudder response when centering rudder stick. 停懸時尾翼向某一邊偏移，或撥動方向舵桿回中立點時，尾翼產生延遲，無法停駐在所欲位置上。	Rudder neutral point improperly set 尾舵中立點設定不恰	Reset rudder neutral point 重設尾舵中立點
	Tail oscillates (hunting, or wags) at hover or full throttle 停懸或全油门時尾翼左右來回搖擺。	Rudder gyro gain too low 尾舵陀螺儀感度偏低	Increase rudder gyro gain 增加尾舵陀螺儀感度
		Rudder gyro gain too high 尾舵陀螺儀感度偏高	Reduce rudder gyro gain 降低尾舵陀螺儀感度
Oscillation during flight 飛行抖動	Elevator and aileron action causes helicopter to oscillate forward/backward or left/right. 升降舵、副翼的打舵動作時，機體前後或左右抖動	Swashplate gain in flight parameters is too high, causing oscillation. 飛行參數中的十字盤感度感度偏高，產生迴旋現象	Lower swashplate gain. 將十字盤感度調低
	Helicopter front bobbles (nods) during forward flight. 直線飛行時，機頭點頭	Worn servo, or slack in control links 伺服器老化，控制結構有虛位	Replace servo, ball link, or linkage balls. 更換伺服器、連桿球、球銷
Drifting during flight 飛行飄移	Helicopter pitches up during forward flight or aileron input causes helicopter to drift 直線飛行機頭上揚或副翼動作飄移	Swashplate gain in flight parameter is too low. 飛行參數中的十字盤感度感度偏低	Increase swashplate gain. 將十字盤感度調高
Control Response 動作反應	Slow Forward/Aft/Left/Right input response 前後左右飛行動作反應偏慢	Flying style or flight response setting or Flight Parameter is too low. 飛行參數中的飛行風格或飛行反應偏低	Increase flying style or flight response. 調高飛行風格或飛行反應
	Sensitive Forward/Aft/Left/Right input response 前後左右飛行動作反應偏快	Flying style of flight response or Flight Parameter is too high. 飛行參數中的飛行風格或飛行反應偏高	Lower flying style or flight response. 調低飛行風格或飛行反應

If above solution does not resolve your issues, please check with experienced pilots or contact your Align dealer.

※在做完以上調整後，仍然無法改善情況時，應立即停止飛行並向有經驗的飛手諮詢或連絡您的經銷商。

## Q&amp;A 1

Gpro cannot power up after power is applied?

- (1) Check if transmitter and helicopter power are on.
- (2) Check for proper power to system, and working power cable between Gpro and receiver.
- (3) Check if proper receiver type selected.
- (4) Check if elevator/aileron channels neutral point is 0 in Gpro's "transmitter and receiver" setting.
- (5) Ensure there are no movement during Gpro's initializing process.

Gpro 接電後 Gpro 無法啟動？

- (1) 檢查發射機及直昇機電源是否開啟。
- (2) 檢查系統電源是否正常，Gpro 與接收器之間電源線是否正確連接。
- (3) 檢查接收器類型是否選擇正確。
- (4) 檢查 Gpro™ 遙控器與接收器™ 設定，升降、副翼頻道中立點是否為 0。
- (5) 注意 Gpro 啟動時機體必須保持靜止，陀螺穩定後 Gpro 才可以啟動。

## Q&amp;A 2

Incorrect washplate movement after setting up Gpro.

- (1) Check if transmitter is set to H-1(1-Servo-Normal) traditional washplate type.
- (2) Check "Swashplate Type" on Gpro is set correctly.
- (3) Check for correct swashplate servo direction.
- (4) Check for correct swashplate servo channel sequence.

Gpro 完成設定後，十字盤動作不正確？

- (1) 檢查遙控器是否有選擇 H-1(1-Servo-Normal) 傳統十字盤模式。
- (2) 檢查 Gpro™ 十字盤類型™ 是否有選擇正確。
- (3) 檢查十字盤伺服機方向設定正確。
- (4) 檢查十字盤伺服機接線順序正確。

## Q&amp;A 3

Helicopter cannot maintain level plane during pirouetting or helicopter tilting forward/back/left/right during takeoff?

Please re-adjust swashplate level.

- (1) Check the auto-tilt sensor is not horizontal when the helicopter is tilted forward/back/left/right during takeoff?

請重新調整十字盤水平。

## Q&amp;A 4

Helicopter tilts forward/back during vertical ascend/descend?

Please adjust the "Collective Pitch Elevator Compensation" option in Flight Parameters. If helicopter's tail dips down when elevator is pulled hard up, this setting can also be adjusted. The more the tail dips, the larger the compensation value.

直昇機直上直下時有前或後傾現象？

請調整飛行參數頁面的“集體螺距升降的補償”直昇機急拉向上如尾巴有下墜現象，可以調整此值，下越嚴重，數值需調越大。

## Q&amp;A 5

Helicopter drifts during flight?

- (1) Increase the "Swashplate Gain" in Flight Parameters.
- (2) Check if the swashplate servos are too slow (recommended spec calls for servo speed within 0.08sec/60degree).
- (3) Note: Only digital servos are supported by Gpro.

直昇機飛行時有飄移現象？

- (1) 將飛行參數頁面的“十字盤增益”調高。
- (2) 檢查驅動十字盤的伺服機是否過慢。(建議選擇動作速度 0.08sec/60 度以內的規格)
- (3) 注意：Gpro 只支援數位伺服機。

## Q&amp;A 6

Unstable hover, oversensitive control effect?

- (1) Try using the "Recommended Beginner Parameters" option in flight parameter menu.
- (2) Lower the "Flying Style" and "Flight Response" parameter in flight parameter menu.

停懸時不穩定，有動作過度敏感現象？

- (1) 可選用飛行參數頁面的“初學者建議參數”。
- (2) 將飛行參數頁面的“飛行風格”與“飛行反應”數值調低。

## Q&amp;A 7

Incorrect helicopter swashplate and rudder compensation direction?

- (1) Check Gpro installation position setting is set correctly.
- (2) Check proper channel sequence of the swash plate servos.

直昇機十字盤與尾舵修正方向錯誤？

- (1) 檢查 Gpro 的陀螺儀安裝位置設定是否正確。
- (2) 檢查十字盤伺服機接線順序是否正確。

## Q&amp;A 8

Can parameters be adjusted through Bluetooth during flight?

No. As a safety precaution, Gpro will disable ESC when entering parameter setting mode. If adjustment to Gpro is done through Bluetooth prior to flight, Gpro needs to be power cycled before flying again.

是否可以飛行時用藍牙傳輸器調整參數？

不行，進入參數設定時，為了安全考量，Gpro 會關閉電子速度器。在飛行前使用藍牙傳輸器調整 Gpro 後，必須重新接電才能飛行。

## Q&amp;A 9

No response when adjusting rudder gain, as if rudder is not compensating.

Check correct setting on rudder gain channel.

- (1) 調整尾舵的感應，沒有反應，尾舵沒有修正動作。
- (2) 檢查尾舵的感應頻道是否設定正確。

## Q&amp;A 10

Spring action after pirouetting.

- (1) Check overall rudder system, and if there are sufficient left/right travel on rudder.
- (2) Insufficient rudder gain. Increase gain until there are slight hunting on the rudder, then slightly back off the gain until ideal feel is achieved.

尾舵自旋轉停止時有回彈現象。

- (1) 檢查尾舵機構及左右行程是否足夠。
- (2) 尾舵感應不足，請將尾舵感應調至有追隨現象，再稍往回調低感應至理想感應。

# ALIGN

## Specifications & Equipment/規格配備:

Length/機身長:1070mm

Height/機身高:337mm

Main Blade Length/主旋翼長:550mm

Main Rotor Diameter/主旋翼直徑:1248mm

Tail Rotor Diameter/尾旋翼直徑:254mm

Motor Drive Gear/馬達齒輪:16T

Main Drive Gear/主齒輪:112T

Autorotation Tail Drive Gear/尾驅動主齒:131T

Tail Drive Gear/尾翼傳動齒:34T

Drive Gear Ratio/齒輪傳動比: 1:7:3.85

Flying Weight/全配重: Approx. 2790g

